



Accesorios baño, papeleras, varios



Índice / Index

Secamanos "JET TIFÓN" "JET FIFON" Hand Dryer	5	Consumibles Exterminador Insectos Refill Insect Killers.....	64
Gamas Ranges	6	Dispensadores Especiales Special Dispensers.....	65
Información general General Information.....	16	Contenedor Sanitario Sanitary Container	67
Secamanos Hand Dryers.....	20	Dispensadores Papel Camilla Bedding Papers Dispensers	68
Secapelos Hair Dryers	24	Consumibles y Aplicaciones Refills and Usages.....	69
Dosificadores Jabón Rellenables Refill Soap Dispensers.....	26	Ayudas Técnicas Grab Bars.....	71
Dosificadores de Jabón Soap Dispensers.....	33	Accesorios Baños Bathroom Accessories	74
Dosificadores Jabón Cartucho Cartridge Soap Dispensers.....	34	Papeleras Bins	82
Cartuchos Jabón para Dosificadores y Aplicaciones Cartridge Soap Dispensers and Usages.....	36	Carros y Contenedores Trolleys and Containers	105
Portabobinas Industrial Roll Dispensers	41	Carros Hotel Hotel Trolleys	106
Portarrollos Jumbo Toilet Roll Dispensers.....	42	Ruedas y Protector Whells and Protector	110
Accesorios para Portarrollos Accessories for Jumbo Roll Dispensers	45	Carros Limpieza Cleaning Trolleys.....	112
Portarrollos Higiénicos Domésticos Domestic Toilet Roll Dispensers.....	46	Limpieza Cleaning.....	114
Dispensadores Combi Combi Dispensers	47	Cenicero Ashtray.....	116
Dispensadores Papel Continuo Towell Roll Dispensers	48	Reposamaletas - Paragüeros - Percheros Suit Case Stand - Umbrella Holders Cloth Hangers.....	117
Cambiadores Pañales Nappy Changing Tables.....	52	Esquemas Eléctricos Electric Schemes.....	119
Dispensador Papel Autocorte Autocut Roll Dispensers	53	Referencias/Páginas References/Pages	120
Dispensadores Toallas de Mano Folded Towel Dispensers.....	54	Notas Notes.....	122
Servilleteros Napkin Dispensers	57		
Dispensadores Toallas Faciales Facial Tissue Dispensers	59		
Difusor Ambiental y Consumibles Air Freshner Dispenser and Refills.....	60		
Exterminador Insectos Insect Killers	61		

- JOFEL debido a la continua mejora de sus productos, se reserva el derecho de cambiar las especificaciones, características y precios en cualquier momento.
- JOFEL se reserva el derecho a cambiar los colores ofertados en el catálogo.
- Due to its continuous product improvement policy, reserves the right to change the product specification, characteristics at any time.
- JOFEL reserves the right to possibly change the products colours of this catalogue.

SECAMANOS "JET TIFÓN"

"JET TIFON" HAND DRYER

AA25050 - AA25550 - AA25650 - AA25950 - AA26550 - AA27550

CARACTERÍSTICAS

- **EVAPORADOR DE AGUA**
 - SISTEMA EXCLUSIVO DE EVAPORACIÓN.
 - NO PRECISA BANDEJA RECOGIDA.
- **FILTRO HEPA**
 - GRANDES DIMENSIONES.
 - MÁS DURACIÓN.
 - MÁS ASPIRACIÓN.
 - MÁS CAUDAL.
- **ABS ANTIBACTERIANO**
 - INYECTADO CON IONES PLATA.
 - EVITA LA FORMACIÓN DE BACTERIAS.
- **SENSORES DE AVISO**
 - FILTRO HEPA.
 - ESCOBILLAS.
 - EVAPORADOR.
- **DIMENSIONES Y PESO**
 - REDUCIDO VOLUMEN.
 - LIGERO (6,65 Kg).
- **AHORRO**
 - AHORRO ENERGÉTICO.
 - DESCONEXIÓN AUTOMÁTICA RESISTENCIA (T>25° C).
- **ALTO RENDIMIENTO Y EFICIENCIA**
 - ALTA VELOCIDAD (540 Km/h).
 - SECADO EN 10".
- **DISEÑO**
 - MODERNO.
 - ATRACTIVO.
 - 6 COLORES.
 - LED PERIMETRAL.
- **PROTECCIÓN AMBIENTAL**
 - CONSUMO.
 - MOTOR.
 - RESISTENCIA.
 - TEMPERATURA AIRE.
- **FÁCIL INSTALACIÓN**

NOVEDAD MUNDIAL
WORLD NOVELTY



AA25550

- Plata
- Silver

AA25050

- Blanco
- Withe

AA25650

- Negro
- Black

AA25950

- Grafito
- Graphite

AA26550

- Frontal: Inox Brillo
- Front Cover: Bright Stainless Steel

AA27550

- Frontal: Inox Satinado
- Front Cover: Satin Stainless Steel

MARZO 2018
MARCH 2018

MARZO 2018
MARCH 2018

CHARACTERISTICS

- **WATER EVAPORATOR**
 - EXCLUSIVE EVAPORATION SYSTEM.
 - DRAINAGE TRAY NOT REQUIRED.
- **HEPA FILTER**
 - LARGE DIMENSIONS.
 - LONGER DURATION.
 - HIGHER ASPIRATION.
 - MORE AIR FLOW.
- **ANTIBACTERIAL ABS**
 - INJECTED WITH SILVER IONS.
 - PREVENTS BACTERIA FROM GROWING.
- **WARNING SENSOR**
 - HEPA FILTER.
 - BRUSHES.
 - EVAPORATOR.
- **DIMENSIONS AND WEIGHT**
 - REDUCED DIMENSIONS.
 - LIGHT (6.65 KG).
- **ECONOMY**
 - ENERGY SAVING.
 - HEATING ELEMENT AUTOMATICALLY DISCONNECTS (T>25° C).
- **HIGH PERFORMANCE AND EFFICIENCY**
 - HIGH SPEED (540 Km/h).
 - 10" DRYING.
- **DESIGN**
 - MODERN.
 - ATTRACTIVE.
 - 6 COLOURS.
 - PERIMETER LED.
- **ENVIRONMENTAL PROTECTION**
 - CONSUMPTION.
 - MOTOR.
 - HEATING ELEMENT.
 - AIR TEMPERATURE.
- **EASY TO INSTALL**

SECAMANOS - HAND DRYERS



AA91000



AA13000



AA18500



AA25550

**NOVEDAD MUNDIAL
WORLD NOVELTY**

**EVAPORACIÓN
AUTOMÁTICA
AUTOMATIC
EVAPORATION**



AA94000



AA16000



AA19000

* APARATOS MÁS REPRESENTATIVOS. | MOST REPRESENTATIVE PRODUCTS.

AZUR



AG33400



AC82000



AC70000



AG43000



AC80000



AC91000



AE51000



AG40000



AG56000



AH33000



AG17550

* APARATOS MÁS REPRESENTATIVOS. | MOST REPRESENTATIVE PRODUCTS.

INOX- STAINLESS STEEL



AH66500



AG35000



AC54000



AC53550



AH75500



AF55500



AE25000



AG45500



AG59000



AH25500

* APARATOS MÁS REPRESENTATIVOS. | MOST REPRESENTATIVE PRODUCTS.

NEGRA - BLACK



AC27650



AC70600



AE67600



AG56600



AG47600



AH37600



AE57600

* APARATOS MÁS REPRESENTATIVOS. | MOST REPRESENTATIVE PRODUCTS.

NÍQUEL - NICKEL



AG14800



AE58300



AC70800



AH52800



AG19800



AG58000



AH38000

* APARATOS MÁS REPRESENTATIVOS. | MOST REPRESENTATIVE PRODUCTS.

ANTIBACTERIANA - ANTIBACTERIAL



AE51700



AC70700



AG40700



AH33700

* APARATOS MÁS REPRESENTATIVOS. | MOST REPRESENTATIVE PRODUCTS.

CLÁSICA - CLASSIC



ALL1006

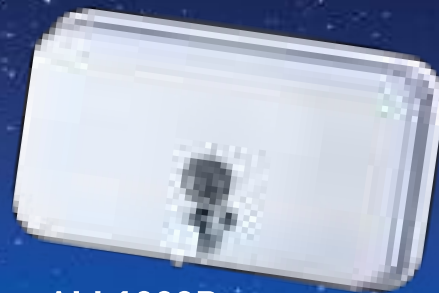

ALL1003B



AF12000



AH12000



AF21000



AF11000



AE12100



AE21000

* APARATOS MÁS REPRESENTATIVOS. | MOST REPRESENTATIVE PRODUCTS.

SMART



AE57000



AC27050



AC96000



AE67000



AG47000



AH37000

* APARATOS MÁS REPRESENTATIVOS. | MOST REPRESENTATIVE PRODUCTS.

PAPELERAS - BINS



AL72035SV



AL74040SV



AL707551G



AL72012C



AL60001



AL707050AVZG



AL709101

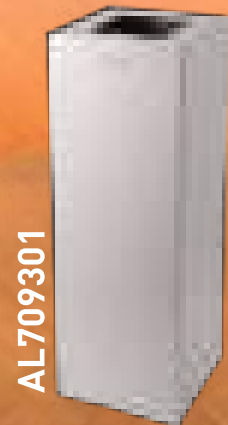

AL709301

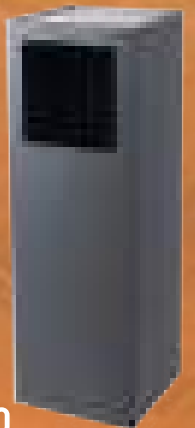

AL709200



AL81400ES



AL71200ES



AL71300ES

* APARATOS MÁS REPRESENTATIVOS. | MOST REPRESENTATIVE PRODUCTS.

ACCESORIOS BAÑO

BATHROOM ACCESSORIES



AW51300



AW81300

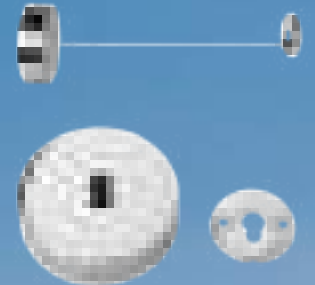

AW61300



AW11300



AW10330



AW41300



AW34300

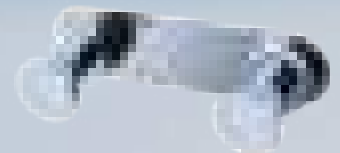

AW22300



AW71300



AW21300

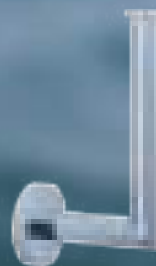

AW42300



AW61000

INFORMACIÓN GENERAL SECAMANOS HAND DRYERS GENERAL INFORMATION

NOVEDAD MUNDIAL
WORLD NOVELTY



AA25050

- ABS Blanco
- White ABS

AA25650

- ABS Negro
- Black ABS

AA26550

- Frontal: Inox Brillo
- Front Cover: Bright S.Steel

AA25550

- ABS Plata
- Silver ABS

AA25950

- ABS Grafito
- Graphite ABS

AA27550

- Frontal: Inox Satinado
- Front Cover: Satin S.Steel

AA18000

- Acero Inox Brillo Óptico
- Bright Stainless Steel Sensor

AA18500

- Acero Inox Satinado Óptico
- Satin Stainless Steel Sensor

AA19000

- ABS Blanco Óptico
- White ABS Sensor

AA19600

- ABS Negro Óptico
- Black ABS Sensor

Denominación Denomination	TIFON	AVE	AVE
Tipo Type	Secamanos Alta Velocidad High Performance Hand Dryers	Secamanos Alta Velocidad High Performance Hand Dryers	Secamanos Alta Velocidad High Performance Hand Dryers
Aplicación Usage	Alta Rotación / High Rotation	Alta Rotación / High Rotation	Alta Rotación / High Rotation
Tiempo Secado Drying Time (seg./sec.)	10	10	10
Tiempo Máx. por Ciclo Max. Time per Cycle (seg./sec.)	30	30	30
Dimensiones Dimensions (mm)	540 x 320 x 180	330 x 260 x 180	330 x 265 x 170
Peso Neto/Bruto Net/Gross Weight (Kg)	6,650 / 7,450	4,185 / 4,980	3,195 / 3,990
Carcasa Cover			
Material Material	ABS	Acero Inox AISI 304 Stainless Steel AISI 304	ABS
Acabado Finish	Blanco - Plata - Grafito - Negro White - Silver - Graphite - Black	Satinado - Brillo Satin - Bright	Blanco - Negro White - Black
Frontal Front Cover (AA26550/27550)*	*Inox - Stainless Steel	—	—
Base Base	ABS	ABS	ABS
Área Secado Hand Area	ABS Antibacteriano Antibacterial ABS	—	—
Motor Motor			
Tipo Type	Universal	Universal	Universal
Potencia Power (W)	1.500	750	750
R.P.M. R.P.M.	30.000	23.000	23.000
Vida Escobillas Brushes Life (ciclos/cycles)	400.000	300.000	300.000
Resistencia Heating Elements (W)	500	650	650
Temperatura Aire Air Temperature (°C)	40	40	40
Presión Acústica Sound Level (dB)	65,6	75	75
Potencia Power (W)	1.500	1.400	1.400
Consumo Consumption (A)	5,2 / 7,5	**3,3 / 6,1	6,1
V/Hz	230-240 / 50-60	230-240 / 50-60	230-240 / 50-60
Protección Protection	IP 21	IP 23	IP 23
Aislamiento Insulation	Clase II / Class II	Clase II / Class II	Clase II / Class II
Accionamiento Operation	Automático / Automatic	Automático / Automatic	Automático / Automatic
Caudal Air Flow (m³/h)	220	220	220
Velocidad Aire Air Speed (Km/h)	540	400	400
Homologación Certification	CE, (GS), (ANCE), (UL), (GTEC), WEEE	CE, (ANCE)	CE, (ANCE)

* Acero Inox Brillo. Anti-huella. | Stainless Steel Anti-fingerprint.

** Antihuella y con sensor de temperatura (3,3 A): "Plus". AA180T0 Inox Brillo. Antihuella. Sensor temperatura. AA185T0 Inox Satinado. Antihuella. Sensor temperatura. Anti-fingerprint and with temperature sensor (3,3 A): "Plus". AA180T0 Bright S.Steel. Anti-fingerprint. Temperature sensor. AA185T0 Satin S.Steel. Anti-fingerprint. Temperature sensor.

**INFORMACIÓN GENERAL
SECAMANOS
HAND DRYERS GENERAL
INFORMATION**



AA92000

- Acero Inox Brillo Óptico
- Bright Stainless Steel Sensor



AA94000

- Vitrificado Óptico
- Vitrified Sensor



AA91000

- Acero Inox Brillo Pulsador
- Bright Stainless Steel Push Button



AA93000

- Vitrificado Pulsador
- Vitrified Push Button

AA92500

- Acero Inox Satinado Óptico
- Satin Stainless Steel Sensor

AA91500

- Acero Inox Satinado Pulsador
- Satin Stainless Steel Push Button

Denominación Denomination	IBERO	IBERO	IBERO	IBERO
Tipo Type	Secamanos / Hand Dryers	Secamanos / Hand Dryers	Secamanos / Hand Dryers	Secamanos / Hand Dryers
Aplicación Usage	Alta/Media Rotación High/Medium Rotation	Alta/Media Rotación High/Medium Rotation	Alta/Media Rotación High/Medium Rotation	Alta/Media Rotación High/Medium Rotation
Tiempo Secado Drying Time (seg./sec.)	20	20	20	20
Tiempo Máx. por Ciclo Max. Time per Cycle (seg./sec.)	25	25	25	25
Dimensiones Dimensions (mm)	220 x 280 x 210	220 x 280 x 210	220 x 280 x 210	220 x 280 x 210
Peso Neto/Bruto Net/Gross Weight (Kg)	3,625 / 4,320	4,385 / 5,085	3,665 / 4,360	4,425 / 5,125
Carcasa Cover				
Material Material	Acero Inox AISI 304 Stainless Steel AISI 304	Acero Inox AISI 304 Stainless Steel AISI 304	Acero Inox AISI 304 Stainless Steel AISI 304	Acero Inox AISI 304 Stainless Steel AISI 304
Acabado Finish	Satinado-Brillo Satin-Bright	Vitrificado / Vitrified	Satinado-Brillo Satin-Bright	Vitrificado / Vitrified
Base Base				
Material Material	ABS	ABS	ABS	ABS
Motor Motor				
Tipo Type	Universal	Universal	Universal	Universal
Potencia Power (W)	200	200	200	200
R.P.M. R.P.M.	4.250	4.250	4.250	4.250
Vida Escobillas Brushes Life (ciclos/cicles)	200.000	200.000	200.000	200.000
Resistencia Heating Elements (W)	1.800	1.800	1.800	1.800
Temperatura Aire Air Temperature (°C)	40	40	40	40
Presión Acústica Sound Level (dB)	77,5	77,5	77,5	77,5
Potencia Power (W)	2.000	2.000	2.000	2.000
Consumo Consumption (A)	8,8	8,8	8,8	8,8
V/Hz	230 / 50	230 / 50	230 / 50	230 / 50
Protección Protection	IP 23	IP 23	IP 23	IP 23
Aislamiento Insulation	Clase II / Class II	Clase II / Class II	Clase II / Class II	Clase II / Class II
Accionamiento Operation	Automático / Automatic	Automático / Automatic	Automático / Automatic	Automático / Automatic
Caudal Air Flow (m³/h)	300	300	300	300
Velocidad Aire Air Speed (Km/h)	121	121	121	121
Homologación Certification	CE, GS, (UL), WEEE	CE, GS, (UL), WEEE	CE, GS, (UL), WEEE	CE, GS, (UL), WEEE

INFORMACIÓN GENERAL SECAMANOS HAND DRYERS GENERAL INFORMATION

**AA14000**

- ABS Blanco Óptico
- White ABS Sensor

**AA16000**

- Acero Inox Brillo Óptico
- Bright Stainless Steel Sensor

**AA13000**

- ABS Blanco Pulsador
- White ABS Push Button

**AA15000**

- Acero Inox Brillo Pulsador
- Bright Stainless Steel Push Button

AA16500

- Acero Inox Satinado Óptico
- Satin Stainless Steel Sensor

AA15500

- Acero Inox Satinado Pulsador
- Satin Stainless Steel Push Button

Denominación Denomination		FUTURA	FUTURA	FUTURA	FUTURA
Tipo Type		Secamanos / Hand Dryers	Secamanos / Hand Dryers	Secamanos / Hand Dryers	Secamanos / Hand Dryers
Aplicación Usage		Media Rotación Medium Rotation	Media Rotación Medium Rotation	Media Rotación Medium Rotation	Media Rotación Medium Rotation
Tiempo Secado Drying Time	(seg. sec.)	30	30	30	30
Tiempo Máx. por Ciclo Max. Time per Cycle	(seg. sec.)	30	30	30	30
Dimensiones Dimensions	(mm)	320 x 225 x 145 mm	318 x 226 x 145 mm	320 x 225 x 145 mm	318 x 226 x 145 mm
Peso Weight	(Kg)	2,915 Kg	3,585 Kg	2,915 Kg	3,585 Kg
Carcasa Cover					
Material Material		ABS	Acero Inox AISI 304 Stainless Steel AISI 304	ABS	Acero Inox AISI 304 Stainless Steel AISI 304
Acabado Finish		Blanco / White	Satinado - Brillo Satin - Bright	Blanco / White	Satinado - Brillo Satin - Bright
Base Base					
Material Material		ABS + PC	ABS + PC	ABS + PC	ABS + PC
Motor Motor					
Tipo Type		Inducción Induction	Inducción Induction	Inducción Induction	Inducción Induction
Potencia Power	(W)	140	140	140	140
R.P.M. R.P.M.		2.800	2.800	2.800	2.800
Resistencia Heating Elements	(W)	1.820	1.820	1.820	1.820
Temperatura Aire Air Temperature	(°C)	55	55	55	55
Presión Acústica Sound Level	(dB)	58	58	58	58
Potencia Power	(W)	1.960	1.960	1.960	1.960
Consumo Consumption	(A)	8,5	8,5	8,5	8,5
V/Hz		230 / 50	230 / 50	230 / 50	230 / 50
Protección Protection		IPX1	IPX1	IPX1	IPX1
Aislamiento Insulation		Clase II / Class II	Clase I / Class I	Clase I / Class I	Clase I / Class I
Accionamiento Operation		Automático - Sensor Automatic - Sensor	Automático - Sensor Automatic - Sensor	Automático - Pulsador Automatic - Push Button	Automático - Pulsador Automatic - Push Button
Caudal Air Flow	(m³/h)	250	250	250	250
Velocidad Aire Air Speed	(Km/h)	70	70	70	70
Homologación Certification		CE, TÜV, GS	CE, TÜV, GS	CE, TÜV, GS	CE, TÜV, GS

INFORMACIÓN GENERAL
SECAPELOS
HAIR DRYERS
GENERAL INFORMATION



SECAPELOS MURAL
“AZUR”
WALL HAIR DRYERS



AB65000

- ABS Blanco
- White ABS

AB65000NC

- ABS Negro
- Black ABS



AB65000GC

- ABS Blanco
- White ABS

AB65180NC

- ABS Negro
- Black ABS

SECAPELOS
“AZUR”
HAIR DRYERS



AB64180NC

- ABS Negro
- Black ABS

SECAPELOS
STANDARD
HAIR DRYERS



AB68500

- ABS Blanco
- White ABS

Denominación Denomination	AZUR	AZUR	AZUR	STANDARD
Tipo Type	Secador de Cabello Mural Wall Hair Dryer	Secador de Cabello Mural Wall Hair Dryer	Secador de Cabello Mural Wall Hair Dryer	Secador de Cabello con Soporte Hair Dryer with Support
Aplicación Usage	Doméstico-Hotel Domestic-Hotel	Doméstico-Hotel Domestic-Hotel	Doméstico-Hotel Domestic-Hotel	Doméstico-Hotel Domestic-Hotel
Dimensiones Dimensions Peso Neto/Bruto Net/Gross Weight	220 x 205 x 100 mm 0,850 / 1,005 Kg	220 x 205 x 100 mm 0,850 / 1,005 Kg	220 x 205 x 100 mm 0,850 / 1,005 Kg	192 x 150 x 74 mm 0,690 / 0,830 Kg
Carcasa Cover				
Material Material	Carcasa ABS - Interior V0 Cover ABS - Inner V0	Carcasa ABS - Interior V0 Cover ABS - Inner V0	Carcasa ABS - Interior V0 Cover ABS - Inner V0	ABS
Acabado Finish	Blanco / White Negro / Black	Blanco / White Negro / Black	Negro / Black	Blanco / White
Base Base				
Material Material	Carcasa ABS - Interior V0 Cover ABS - Inner V0	Carcasa ABS - Interior V0 Cover ABS - Inner V0	Carcasa ABS - Interior V0 Cover ABS - Inner V0	ABS Blanco White ABS
Motor Motor				
Tipo Type	Universal	Universal	Universal	Universal
Resistencia Heating Element	Si / Yes	Si / Yes	Si / Yes	Si / Yes
Temperatura Aire Air Temperature	62 °C (a 10 cm) 62 °C (to 10 cm)	62 °C (a 10 cm) 62 °C (to 10 cm)	62 °C (a 10 cm) 62 °C (to 10 cm)	65 °C
Presión Acústica Sound Level	63 dB	63 dB	63 dB	55 dB
Potencia Power	1.400 W	1.800 W	1.800 W	1.200 W
Consumo Consumption	6,1 A	7,8 A	6,1 A	5,2 A
V/Hz	230V / 50 Hz	230V / 50 Hz	230V / 50 Hz	230V / 50 Hz
Aislamiento Insulation	Clase II / Class II	Clase II / Class II	Clase II / Class II	Clase II / Class II
Accionamiento Operation	Pulsador - 3 Velocidades Push Button - 3 Speeds	Pulsador - 3 Velocidades Push Button - 3 Speeds	Pulsador - 3 Velocidades Push Button - 3 Speeds	Pulsador - 2 Velocidades Push Button - 2 Speeds
Caudal Air Flow	23,610 m³/h	23,610 m³/h	23,610 m³/h	23,610 m³/h
Velocidad Aire Air Speed	85 Km/h	85 Km/h	85 Km/h	65 Km/h
Homologación Certification	CE, TÜV, GS	CE, TÜV, GS	CE, TÜV, GS	CE

* AB64180NC: Con bolsa. | AB64180NC: With bag.

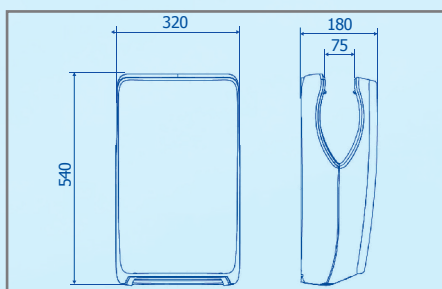

Dimensiones embalaje: (mm) 605
Packaging dimensions: 380 270

SECAMANOS "JET TIFÓN" "JET TIFON" HAND DRYERS

**NOVEDAD MUNDIAL
WORLD NOVELTY**

AA25050 - AA25550 - AA25650 - AA25950 - AA26550 - AA27550

- SISTEMA EXCLUSIVO DE EVAPO-RACIÓN DEL AGUA (PATENTADO).
- NO PRECISA BANDEJA DE RECOGIDA.
- Área secado en ABS Antibacteriano.
- Inyectado con iones Plata.
- Filtro HEPA grandes dimensiones.
- Sensores de aviso: Filtro HEPA, Evaporador, Escobillas.
- Reducido volumen.
- Ligero (6,650 Kg).
- Ahorro energético.
- Desconexión automática resistencia con temperatura ambiente >25 °C.
- Alto rendimiento: 540 Km/h.
- Secado 10".
- Protección ambiental.
- Moderno y atractivo.
- Led perimetral.
- Cuatro Colores: Blanco, Plata, Grafito y Negro.
- Frontal Acero Inox Anti-huella.

- EXCLUSIVE EVAPORATION SYSTEM (PROPRIETARY).
- DRAINAGE TRAY NOT REQUIRED.
- Hands area Antibacterial ABS.
- Injected with silver ions.
- HEPA Filter: large dimensions.
- Warning sensors: HEPA Filter, Evaporator, Brushes.
- Reduced volume.
- Light (6,650 Kg).
- Energy saving.
- Heating element disconnects when room temperature 25 °C.
- High speed: 540 Km/h.
- 10" Drying.
- Environmental protection.
- Modern and attractive.
- Perimeter Led.
- Four Colors: White, Silver, Graphite and Black.
- Front Cover S.Steel Anti-fingerprint.



AA25050

- ABS Antibacteriano Blanco
- Antibacterial ABS White



AA25650

- ABS Antibacteriano Negro
- Antibacterial ABS Black



AA26550*

- Frontal: Inox Brillo
- Front Cover: Bright Stainless Steel

**MARZO 2018
MARCH 2018**



AA25550

- ABS Antibacteriano Plata
- Antibacterial ABS Silver



AA25950

- ABS Antibacteriano Grafito
- Antibacterial ABS Graphite



AA27550*

- Frontal: Inox Satinado
- Front Cover: Satin Stainless Steel

**MARZO 2018
MARCH 2018**

Características Técnicas Technical Characteristics	AA25050	AA25550	AA25650	AA25950	AA26550	AA27550
Material Material	ABS	ABS	ABS	ABS	ABS + Inox ABS + S.Steel	ABS + Inox ABS + S.Steel
Colores Colours	Blanco / White	Plata / Silver	Negro / Black	Grafito / Graphite	Plata+Inox / Silver+S.Steel	Plata+Inox / Silver+S.Steel
V/Hz	230-240 / 50-60	230-240 / 50-60	230-240 / 50-60	230-240 / 50-60	230-240 / 50-60	230-240 / 50-60
Consumo Consumption (A)	5'2 - 7'5	5'2 - 7'5	5'2 - 7'5	5'2 - 6'7	5'2 - 6'7	5'2 - 6'7
Motor Motor	Universal	Universal	Universal	Universal	Universal	Universal
Potencia Motor Motor Power (W)	1.500	1.500	1.500	1.500	1.500	1.500
Resistencia Heating Power (W)	500	500	500	500	500	500
Peso Neto/Bruto Net/Gross Weight (Kg)	6,650 / 7,450	6,650 / 7,450	6,650 / 7,450	6,650 / 7,450	7,710 / 8,510	7,710 / 8,510
R.P.M.	30.000	30.000	30.000	30.000	30.000	30.000
Caudal Aire Air Flow (m³/h)	220 m³/h	220 m³/h	220 m³/h	220 m³/h	220 m³/h	220 m³/h
Acústica (2 m) Sound Level (2 m) (dB)	65,6 dB	65,6 dB	65,6 dB	65,6 dB	65,6 dB	65,6 dB
Temp. del Aire Air Temperature (°C)	40 °C	40 °C	40 °C	40 °C	40 °C	40 °C
Aislamiento Eléctrico Electrical Insulation	Clase II / Class II	Clase II / Class II	Clase II / Class II	Clase II / Class II	Clase II / Class II	Clase II / Class II
Protección Protection	IP21	IP21	IP21	IP21	IP21	IP21
Homologación Certification	CE, (GS), (ANCE), (UL), (GTEC), WEEE	CE, (GS), (ANCE), (UL), (GTEC), WEEE	CE, (GS), (ANCE), (UL), (GTEC), WEEE	CE, (GS), (ANCE), (UL), (GTEC), WEEE	CE, (GS), (ANCE), (UL), (GTEC), WEEE	CE, (GS), (ANCE), (UL), (GTEC), WEEE

* Frontal | Front Cover: Acero Inox AISI 304 | Stainless Steel AISI 304.

- FIJACIÓN: 3 tornillos + 3 tacos (incluidos). | FIXING: 3 screws + 3 plugs (included).
- EMBALAJE: Unitario. | PACKAGING: Single.

HOMOLOGACIÓN/CERTIFICATION. En proceso | In progress ().

- LIMPIEZA: Bayeta húmeda. No usar productos químicos. CLEANING: Damp cloth. Don't use chemicals.

● ESQUEMAS ELÉCTRICOS: Pág. 119. | ELECTRICAL SCHEMES: Page 119.



SECAMANOS "FUTURA" "FUTURA" HAND DRYERS

AA13000 - AA14000 - AA15000 - AA15500 - AA16000 - AA16500

- Espacio rotación media/baja.
- Tiempo de secado aprox.: 30".
- No precisa mantenimiento.
- Baja rumorosidad.
- Parada automática por tiempo.
- Sistema de seguridad con parada.

- Places with medium/low medium traffic.
- Approximate dry time: 30".
- No maintenance required.
- Quiet sound level.
- With timer for automatic shutdown.
- Security system with automatic stop.

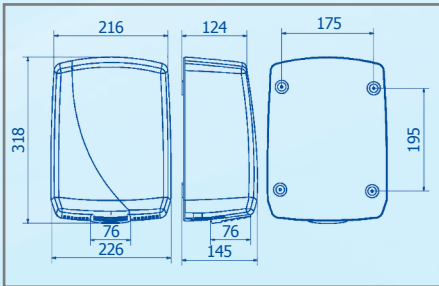

Dimensiones embalaje: (mm) 380
Packaging dimensions: 225 290



AA13000

- ABS Blanco Pulsador
- White ABS Push Button



AA14000

- ABS Blanco Óptico
- White ABS Sensor



AA15000

- Acero Inox Brillo Pulsador
- Bright Stainless Steel Push Button



AA15500

- Acero Inox Satinado Pulsador
- Satin Stainless Steel Push Button



AA16000

- Acero Inox Brillo Óptico
- Bright Stainless Steel Sensor



AA16500

- Acero Inox Satinado Óptico
- Satin Stainless Steel Sensor

Características Técnicas Technical Characteristics		AA13000	AA14000	AA15000	AA15500	AA16000	AA16500
V/Hz		230 / 50	230 / 50	230 / 50	230 / 50	230 / 50	230 / 50
Consumo Consumption	(A)	8,5	8,5	8,5	8,5	8,5	8,5
Motor Motor	(W)	140	140	140	140	140	140
Resistencia Heating Power	(W)	1.820	1.820	1.820	1.820	1.820	1.820
Total Total	(W)	1.960	1.960	1.960	1.960	1.960	1.960
Peso Neto Net Weight	(Kg)	2,915	2,915	3,585	3,585	3,585	3,585
Peso Bruto Gross Weight	(Kg)	3,455	3,455	4,165	4,165	4,165	4,175
R.P.M.		2.800	2.800	2.800	2.800	2.800	2.800
Caudal Aire Air Flow	(m³/h)	250	250	250	250	250	250
Acústica Sound Level	(dB)	58	58	58	58	58	58
Temp. del Aire Air Temperature	(°C)	55	55	55	55	55	55
Clase Class		II	II	I	I	I	I
Protección Protection		IPX1	IPX1	IPX1	IPX1	IPX1	IPX1
Homologación Certification		CE, TÜV, GS	CE, TÜV, GS	CE, TÜV, GS	CE, TÜV, GS	CE, TÜV, GS	CE, TÜV, GS

- FIJACIÓN: 4 tornillos + 4 tacos (incluidos).
FIXING: 4 screws + 4 plugs (included).
- EMBALAJE: Unitario. | PACKAGING: Single.

- LIMPIEZA: Bayeta húmeda. No usar productos químicos.
CLEANING: Damp cloth. Don't use chemicals.
- ESQUEMAS ELÉCTRICOS: Pág. 119. | ELECTRICAL SCHEMES: Page 119.

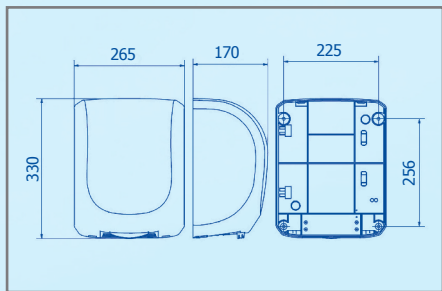

Dimensiones embalaje: (mm) 375
Packaging dimensions: 340 220



SECAMANOS ALTO RENDIMIENTO "AVE" "AVE" ULTRA FAST HAND DRYERS

AA18000 - AA18500 - AA19000 - AA19600

- Espacio rotación alta.
- Tiempo de secado aprox.: 10".
- Antivandálico y antivibración.
- Doble aislamiento eléctrico.
- Parada automática por tiempo.
- Sistema de seguridad con parada.

- Places with high traffic of people.
- Approximate dry time: 10".
- Anti-vandalism and anti-shake system.
- Double electrical insulation.
- With timer for automatic shutdown.
- Security system with automatic stop.



AA18000

- Acero Inox Brillo Óptico
- Bright Stainless Steel Sensor



AA18500

- Acero Inox Satinado Óptico
- Satin Stainless Steel Sensor



AA19000

- ABS Blanco Óptico
- White ABS Sensor



AA19600

- ABS Negro Óptico
- Black ABS Sensor

Características Técnicas Technical Characteristics		AA18000	AA18500	AA19000	AA19600
V/Hz		230 / 50	230 / 50	230 / 50	230 / 50
Consumo Consumption	(A)	* 3,3 / 6,1	* 3,3 / 6,1	6,1	6,1
Motor Motor	(W)	750	750	750	750
Resistencia Heating Power	(W)	650	650	650	650
Total Total	(W)	1.400	1.400	1.400	1.400
Peso Neto Net Weight	(Kg)	4,185	4,185	3,195	3,195
Peso Bruto Gross Weight	(Kg)	4,980	4,980	3,990	3,990
R.P.M.		23.000	23.000	23.000	23.000
Caudal Aire Air Flow	(m³/h)	220	220	220	220
Velocidad del Aire Air Speed	(km/h)	400	400	400	400
Acústica Sound Level	(dB)	75	75	75	75
Temp. del Aire Air Temperature	(°C)	40	40	40	40
Clase Class		II	II	II	II
Protección Protection		IP23	IP23	IP23	IP23
Homologación Certification		CE	CE	CE	CE

* Antihuella y con sensor de temperatura (3,3 A): "Plus". AA180T0 Inox Brillo. Antihuella. Sensor temperatura. AA185T0 Inox Satinado. Antihuella. Sensor temperatura.

* Anti-fingerprint and with temperature sensor (3'3 A): "Plus". AA180T0 Bright S.Steel. Anti-fingerprint. Temperature sensor. AA185T0 Satin S.Steel. Anti-fingerprint. Temperature sensor.

- FIJACIÓN: 4 tornillos + 4 tacos (incluidos).
FIXING: 4 screws + 4 plugs (included).
- EMBALAJE: Unitario. | PACKAGING: Single.

- LIMPIEZA: Bayeta húmeda. No usar productos químicos.
CLEANING: Damp cloth. Don't use chemicals.
- ESQUEMAS ELÉCTRICOS: Pág. 119. | ELECTRICAL SCHEMES: Page 119.



SECAMANOS "ÍBERO" "IBERO" HAND DRYERS

AA91000 - AA91500 - AA92000 - AA92500 - AA93000 - AA94000

- Espacio rotación alta/media.
- Tiempo de secado aprox.: 20".
- Antivandálico y antivibración.
- Tobera giratoria 360°.
- Parada automática por tiempo.
- Sistema de seguridad con parada.

- For places with medium to high traffic of people.
- Approximate dry time: 20".
- Anti-vandal and anti-shake system.
- 360° rotating nozzle.
- With timer for automatic shutdown.
- Security system with automatic stop.

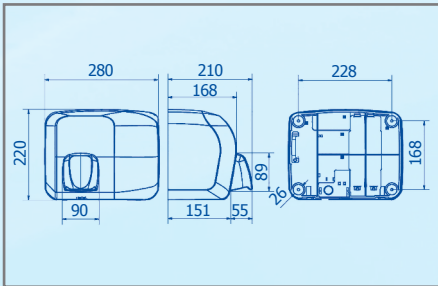

Dimensiones embalaje: (mm) 285
Packaging dimensions: 345 295



AA91000

- Acero Inox Brillo Pulsador
- Bright Stainless Steel Push Button



AA91500

- Acero Inox Satinado Pulsador
- Satin Stainless Steel Push Button



AA92000

- Acero Inox Brillo Óptico
- Bright Stainless Steel Sensor



AA92500

- Acero Inox Satinado Óptico
- Satin Stainless Steel Sensor



AA93000

- Acero Vitrificado Pulsador
- Vitrified Steel Push Button



AA94000

- Acero Vitrificado Óptico
- Vitrified Steel Sensor

Características Técnicas Technical Characteristics		AA91000	AA91500	AA92000	AA92500	AA93000	AA94000
V/Hz		230 / 50	230 / 50	230 / 50	230 / 50	230 / 50	230 / 50
Consumo Consumption	(A)	8,8	8,8	8,8	8,8	8,8	8,8
Motor Motor	(W)	200	200	200	200	200	200
Resistencia Heating Power	(W)	1.800	1.800	1.800	1.800	1.800	1.800
Total Total	(W)	2.000	2.000	2.000	2.000	2.000	2.000
Peso Neto Net Weight	(Kg)	3,665	3,665	3,625	3,625	4,425	4,385
Peso Bruto Gross Weight	(Kg)	4,360	4,360	4,320	4,320	5,125	5,085
R.P.M.		4.250	4.250	4.250	4.250	4.250	4.250
Caudal Aire Air Flow	(m³/h)	300	300	300	300	300	300
Acústica Sound Level	(dB)	77,5	77,5	77,5	77,5	77,5	77,5
Temp. del Aire Air Temperature	(°C)	40	40	40	40	40	40
Clase Class		II	II	II	II	II	II
Protección Protection		IP23	IP23	IP23	IP23	IP23	IP23
Homologación Certification		CE, TÜV, GS, UL	CE, TÜV, GS, UL	CE, TÜV, GS, UL	CE, TÜV, GS, UL	CE, TÜV, GS, UL	CE, TÜV, GS, UL

- FIJACIÓN: 4 tornillos + 4 tacos (incluidos).
FIXING: 4 screws + 4 plugs (included).
- EMBALAJE: Unitario. | PACKAGING: Single.

- LIMPIEZA: Bayeta húmeda. No usar productos químicos.
CLEANING: Damp cloth. Don't use chemicals.
- ESQUEMAS ELÉCTRICOS: Pág. 119. | ELECTRICAL SCHEMES: Page 119.

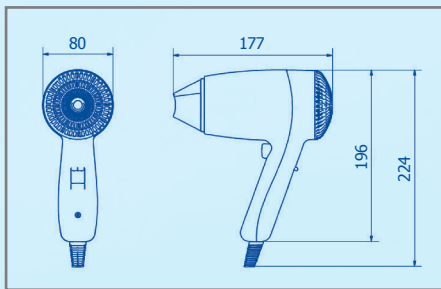

Dimensiones embalaje: (mm) 237
Packaging dimensions: 220 108

AB80000

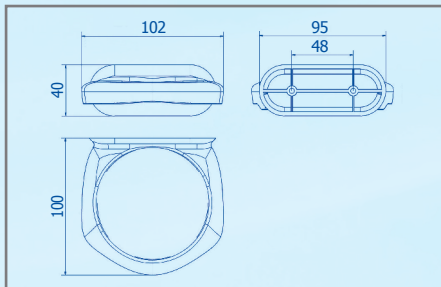

SECAPELOS CON BOLSA HAIR DRYERS WITH BAG

AB64180NC - AB80000 (Soporte, no incluido / Support, not included)

- ABS Negro.
- Interruptor marcha y paro.
- Aire caliente.
- 3 velocidades.
- Ignífugo.
- Pulsador de seguridad.
- Clase II.
- Filtro antipelos desmontable.
- Altas prestaciones.
- AB64180NC: Aparato con su bolsa.
- AB80000: Soporte para aparato (no incluido).
- Cable extensible largo.
- Black ABS.
- Run/Stop switch.
- Hot air.
- 3 speeds.
- Fireproof.
- Security push button.
- Class II.
- Removable anti-hairs filter.
- High performances.
- AB64180NC: Hair dryers with bag.
- AB80000: Support hair dryer (no included).
- Long extensible cable.



AB64180NC*

- ABS Negro
- ABS Black

* AB64180NC: Bolsa incluida.
Included Bag.



AB80000**

- ABS Negro
- ABS Black

** AB80000: Soporte no incluido.
Not included support.

Características Técnicas | Technical Characteristics

		AB64180NC
V/Hz		230 / 50
Consumo Consumption	(A)	7,8
Potencia Total Total Power	(W)	1.800
Peso Neto/Bruto Net/Gross Weight	(Kg)	0,570 / 0,720
Caudal Aire Air Flow	(m³/h)	85
Acústica Sound Level	(dB)	63
Temp. Aire Air Temperature	(°C)	62
Homologación Certification		CE, TÜV, GS

- FIJACIÓN: 2 tornillos + 2 tacos (incluidos). | FIXING: 2 screws + 2 wall plugs (included).
- EMBALAJE: Unitario. | PACKAGING: Single.
- LIMPIEZA: Bayeta húmeda. No usar productos químicos. | CLEANING: Damp cloth. Don't use chemicals.





SECAPELOS HAIR DRYERS

AB65000 - AB65000GC - AB65000NC - AB65180NC

- Interruptor marcha y paro.
- Aire caliente: 3 velocidades.
- Ignífugo.
- Pulsador de seguridad.
- Clase II.
- Diferentes potencias y colores.
- Run/Stop switch.
- Hot air: 3 speeds.
- Fireproof.
- Security push button.
- Class II.
- Available in different colours and powers.

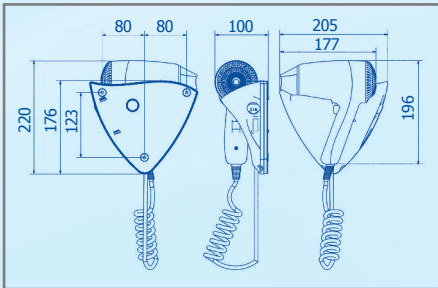

Dimensiones embalaje: (mm) 240
Packaging dimensions: 218 105



AB65000
AB65000GC

- ABS Blanco
- White ABS



AB65000NC
AB65180NC

- ABS Negro
- Black ABS

Características Técnicas Technical Characteristics	AB65000	AB65000GC	AB65000NC	AB65180NC
V/Hz	230 / 50	230 / 50	230 / 50	230 / 50
Consumo Consumption (A)	6,1	7,8	6,1	7,8
Potencia Total Total Power (W)	1.400	1.800	1.400	1.800
Peso Neto/Bruto Net/Gross Weight (Kg)	0,850 / 1,005	0,850 / 1,005	0,850 / 1,005	0,850 / 1,005
Velocidad Aire Air Speed (Km/h)	85	85	85	85
Caudal Aire Air Flow (m³/h)	23,610	23,610	23,610	23,610
Acústica Sound Level (dB)	63	63	63	63
Temp. del Aire Air Temperature (°C)	62	62	62	62
Homologación Certification	CE, TÜV, GS	CE, TÜV, GS	CE, TÜV, GS	CE, TÜV, GS

- FIJACIÓN: 3 tornillos + 3 tacos (incluidos). | FIXING: 3 screws + 3 wall plugs (included).
- EMBALAJE: Unitario. | PACKAGING: Single.
- LIMPIEZA: Bayeta húmeda. No usar productos químicos. | CLEANING: Damp cloth. Don't use chemicals.



SECAPELOS STANDARD STANDARD HAIR DRYERS

AB68500

- Interruptor marcha y paro.
- Aire caliente: 2 velocidades.
- Cable extensible largo.
- Pulsador de seguridad.
- Ergonómico.
- Clase II.
- Run/stop switch.
- Hot air: 2 different speeds.
- Long extensible cable.
- Security push button.
- Ergonomic.
- Class II.

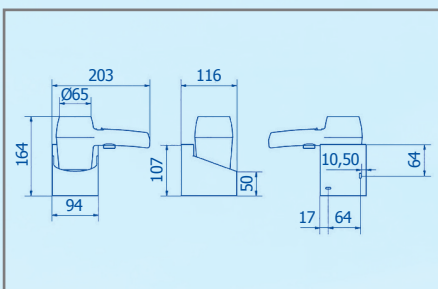

Dimensiones embalaje: (mm) 250
Packaging dimensions: 218 105

Características Técnicas Technical Characteristics	AB68500
V/Hz	230 / 50
Consumo Consumption (A)	5,2
Potencia Total Total Power (W)	1.200
Peso Neto/Bruto Net/Gross Weight (Kg)	0,690 / 0,830
Velocidad Aire Air Speed (Km/h)	65
Caudal Aire Air Flow (m³/h)	23,610
Acústica Sound Level (dB)	55
Temp. Aire Air Temperature (°C)	65
Homologación Certification	CE, TÜV, GS

- FIJACIÓN: 3 tornillos + 3 tacos (incluidos). | FIXING: 3 screws + 3 wall plugs (included).
- EMBALAJE: Unitario. | PACKAGING: Single.
- LIMPIEZA: Bayeta húmeda. No usar productos químicos. | CLEANING: Damp cloth. Don't use chemicals.

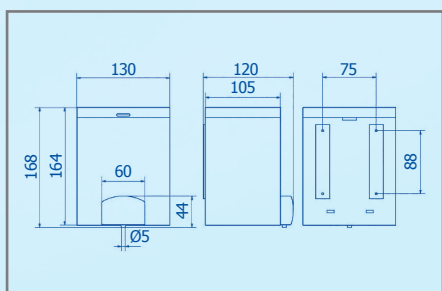

Dimensiones embalaje: (mm) 175
Packaging dimensions: 135 135

DOSIFICADOR JABÓN “VISIÓN” RELLENABLES “VISION” REFILL SOAP DISPENSERS AC21150 - AC22000

- Total visión de la carga.
- Depósito transparente en SAN fumé.
- Base y pulsador ABS gris.
- Cerradura con llave.
- Dosis pulsación: 1 gr.
- Content entirely visible.
- Transparent deposit, made of smoked SAN.
- Base and push button of grey ABS.
- Key lock.
- Dose per pulsation: 1gr.



AC21150

- SAN Fumé Pulsador
- Smoke SAN Push Button



AC22000

- SAN Fumé Pulsador
- Smoke SAN Push Button

Características Técnicas Technical Characteristics	AC21150	AC22000
Tapa Top	Inox Satinado Satin S. Steel	Inox Satinado Satin S. Steel
Carcasa Cover	SAN Fumé Smoke SAN	SAN Fumé Smoke SAN
Capacidad Volume	(L) 1,400	2,000
Peso Neto/Bruto Net/Gross Weight	(Kg) 0,510 / 0,575	0,660 / 0,760

- FIJACIÓN: 3 tornillos + 3 tacos (incluidos). | FIXING: 3 screws + 3 wall plugs (included).
- EMBALAJE: Unitario. | PACKAGING: Single.
- LIMPIEZA: Bayeta húmeda. No usar productos químicos. | CLEANING: Damp cloth. Don't use chemicals.

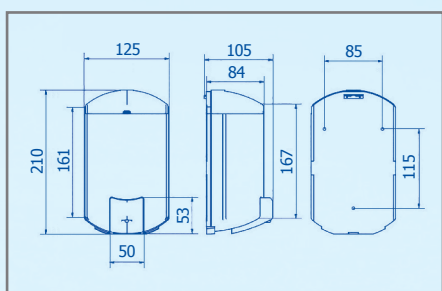

Dimensiones embalaje: (mm) 218
Packaging dimensions: 135 105

DOSIFICADOR JABÓN “AITANA LUX” RELLENABLE “AITANA LUX” REFILL SOAP DISPENSER AC71000

- Dosificador rellenable con tapa Inox.
- Total visión de la carga.
- Depósito transparente en SAN fumé.
- Cerradura con llave.
- Dosis pulsación: 1 gr.
- Refill dispenser with inox cover.
- Content entirely visible.
- Transparent deposit made of smoked SAN.
- Key lock.
- Dose per pulsation: 1 gr.

Características Técnicas Technical Characteristics	AC71000
Carcasa Cover	SAN
Acabado Finish	Fumé / Smoke
Tapa Top	Inox Satinado / Satin S. Steel
Base Base	ABS Gris / Grey ABS
Pulsador Push Button	ABS Gris / Grey ABS
Capacidad Volume	(L) 0,900
Peso Neto Net Weight	(Kg) 0,470
Peso Bruto Gross Weight	(Kg) 0,505

- FIJACIÓN: 3 tornillos + 3 tacos (incluidos). | FIXING: 3 screws + 3 wall plugs (included).
- EMBALAJE: Unitario. | PACKAGING: Single.
- LIMPIEZA: Bayeta húmeda. No usar productos químicos. | CLEANING: Damp cloth. Don't use chemicals.



DOSIFICADOR JABÓN "SMART" RELLENABLES "SMART" REFILL SOAP DISPENSERS

AC27050 - AC27650

- Dosificadores rellenables ABS.
- Cerradura con llave.
- Visor de carga.
- Pulsador integrado en carcasa.
- Depósito de Polietileno.
- Línea económica "Low Cost".

- Refill ABS dispensers.
- Key lock (key provided).
- Content viewer.
- Push button integrated on cover.
- Polyethylene deposit.
- "Low Cost" range of products.

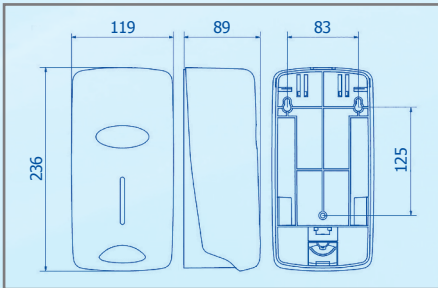

Dimensiones embalaje: (mm) 275
Packaging dimensions: 128 112



AC27050

- ABS Blanco Pulsador
- White ABS Push Button



AC27650

- ABS Negro Pulsador
- Black ABS Push Button

Características Técnicas Technical Characteristics		AC27050	AC27650
Capacidad Volume	(L)	1.000	1.000
Peso Neto/Bruto Net/Gross Weight	(Kg)	0,360 / 0,455	0,360 / 0,455
Dosis Dose	(gr)	1	1
Jabón Soap		Líquido / Liquid	Líquido / Liquid

- FIJACIÓN: 4 tornillos + 4 tacos (incluidos). | FIXING: 4 screws + 4 wall plugs (included).
- EMBALAJE: Unitario. | PACKAGING: Single.
- LIMPIEZA: Bayeta húmeda. No usar productos químicos. | CLEANING: Damp cloth. Don't use chemicals.



DOSIFICADOR JABÓN "AZUR" RELLENABLES "AZUR" REFILL SOAP DISPENSERS

AC82000 - AC82020 - AC84000 - AC84020

- Dosificadores rellenables.
- Válvula antigoteo y anticorrosión.
- Cerradura con llave.
- Carga superior.
- Opción: Blanca y Fumé
- Soporte y pulsador en ABS Blanco.

- Refills dispensers.
- Non-drip and anti-corrosion valve.
- Key lock
- Refilled by top.
- Available in White and Smoke finish.
- Base and push button made of White ABS.

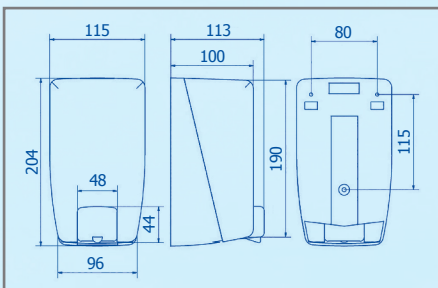

Dimensiones embalaje: (mm) 208
Packaging dimensions: 133 125



AC82000



AC82020



AC84000



AC84020

Características Técnicas Technical Characteristics		AC82000	AC82020	AC84000	AC84020
Carcasa Cover		SAN	SAN	SAN	SAN
Acabado Finish		Fumé / Smoke	Blanco / White	Fumé / Smoke	Blanco / White
Tapa Cover		SAN Fumé SAN Smoke	SAN Blanco SAN White	SAN Fumé SAN Smoke	SAN Blanco SAN White
Capacidad Volume	(L)	1,000	1,000	0,400	0,400
Peso Neto/Bruto Net/Gross Weight	(Kg)	0,470 / 0,540	0,470 / 0,540	0,250 / 0,550	0,250 / 0,550
Dosis Dose	(gr)	1	1	1	1

- FIJACIÓN: 3 tornillos + 3 tacos (incluidos). | FIXING: 3 screws + 3 wall plugs (included).
- EMBALAJE: Refs. AC82000 y AC82020: Unitario. Refs. AC84000 y AC84020: 2 unidades por caja. | PACKAGING: Refs. AC82000 and AC82020: Single. Refs.

AC84000 and AC84020: 2 units for packaging.

- LIMPIEZA: Bayeta húmeda. No usar productos químicos. | CLEANING: Damp cloth. Don't use chemicals.



DOSIFICADOR JABÓN "AITANA" RELLENABLES "AITANA" REFILL SOAP DISPENSERS

AC70000 - AC70600 - AC70700 - AC70800 - AC72000 - AC79000 - AC79500

- Dosificadores rellenables ABS.
- Válvula antigoteo y anticorrosión.
- Cerradura con llave.
- Total visión de la carga.
- Pulsador integrado en carcasa.
- Depósito en SAN transparente.
- Refill dispensers made of ABS.
- Non-drip and anti-corrosion valve.
- Key lock (key provided).
- Content entirely visible.
- Push button integrated in cover.
- Transparent deposit made of SAN.

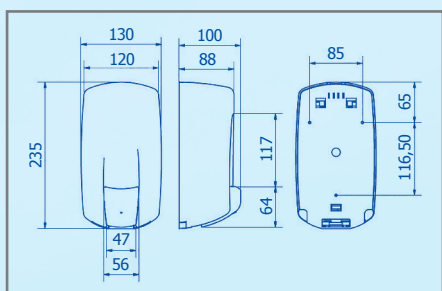

Dimensiones embalaje: (mm) 242
Packaging dimensions: 133 120



AC70000

- ABS Blanco Pulsador
- White ABS Push Button



AC70600

- ABS Negro Pulsador
- Black ABS Push Button



AC70700

- ABS Antibac Blanco Pulsador
- Antibac ABS White Push Button



AC70800

- ABS Niquelado Pulsador
- Nicked ABS Push Button



AC72000

- ABS Metalizado Pulsador
- Metalised ABS Push Button



AC79000

- Acero Inox Satinado Pulsador
- Satin Stainless Steel Push Button



AC79500

- Acero Inox Brillo Pulsador
- Bright Stainless Steel Push Button

Características Técnicas Technical Characteristics	AC70000	AC70600	AC70700	AC70800	AC72000	AC79000	AC79500
Carcasa Cover	ABS	ABS	ABS Antibac Antibac ABS	ABS	ABS	Inox Stainless Steel	Inox Stainless Steel
Acabado Finish	Blanco White	Negro Black	Blanco White	Niquelado Nicked	Metalizado Metalised	Satinado Satin	Brillo Bright
Base Base	ABS Blanco White ABS	ABS Negro Black ABS	ABS Blanco White ABS	ABS Negro Black ABS	ABS	ABS	ABS
Pulsador Push Button	ABS Gris Grey ABS	ABS Cromado Chromed ABS	ABS Gris Grey ABS	ABS Negro Black ABS	ABS Gris Grey ABS	ABS Niquelado Nicked ABS	ABS Niquelado Nicked ABS
Depósito Deposit	SAN	SAN	SAN	SAN	SAN	SAN	SAN
Capacidad Volume (L)	0,900	0,900	0,900	0,900	0,900	0,900	0,900
Peso Neto Net Weight (Kg)	0,410	0,410	0,410	0,410	0,410	0,595	0,595
Peso Bruto Gross Weight (Kg)	0,480	0,480	0,480	0,480	0,480	0,670	0,670
Dosis Dose (gr)	1	1	1	1	1	1	1

• FIJACIÓN: 3 tornillos + 3 tacos (incluidos). | FIXING: 3 screws + 3 wall plugs (included).
• EMBALAJE: Unitario. | PACKAGING: Single.

• LIMPIEZA: Bayeta húmeda. No usar productos químicos.
CLEANING: Damp cloth. Don't use chemicals.



DOSIFICADOR JABÓN "AITANA" PARA CODO "AITANA ELBOW" REFILL SOAP DISPENSER AC75000

- Dosificador rellenable.
- Válvula antigoteo y anticorrosión.
- Cerradura con llave.
- Total visión de carga.
- Dispositivo acciona pulsador.
- Depósito transparente en SAN.
- Refill dispenser.
- Non-drip and anti-corrosion valve.
- Key lock.
- Content entirely visible.
- Mechanism to operate push button.
- Transparent deposit made of SAN.

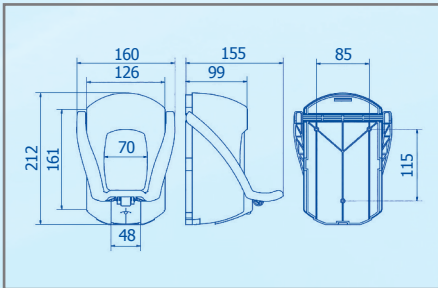

Dimensiones embalaje: (mm) 225
Packaging dimensions: 170 270

Características Técnicas Technical Characteristics	AC75000
Carcasa Cover	ABS
Acabado Finish	Blanco / White
Base Base	ABS Blanco / White ABS
Capacidad Volume (L)	0,900
Peso Neto/Bruto Net/Gross Weight (Kg)	0,295 / 1,340 (2 u.)
Dosis Dosses Dose (gr)	1

- FIJACIÓN: 3 tornillos + 3 tacos (incluidos). | FIXING: 3 screws + 3 wall plugs (included).
- EMBALAJE: Unitario. | PACKAGING: Single.
- LIMPIEZA: Bayeta húmeda. No usar productos químicos. | CLEANING: Damp cloth. Don't use chemicals.



DOSIFICADOR DE JABÓN DE CODO RELLENABLE EURO BOTTLE REFILL SOAP DISPENSER AC14000

- Dosificador rellenable ABS.
- Depósito de Polietileno.
- Válvula antigoteo y anticorrosión.
- Cerradura con llave.
- Palanca de acción de acero Inox.
- Suministrado con botella rellenable (vacía).
- Total visión de la carga.
- Refill dispensers, made of ABS.
- Polyethylene deposit.
- Non-drip and anti-corrosion valve.
- Key lock (key provided).
- Lever made of inox steel.
- Supplied with refillable bottle (empty).
- Content entirely visible.

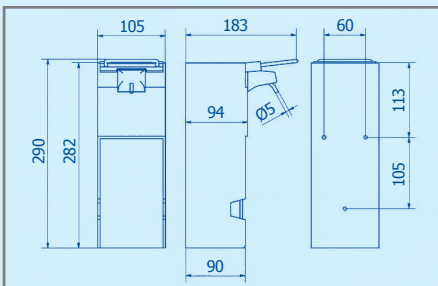

Dimensiones embalaje: (mm) 305
Packaging dimensions: 110 195

Características Técnicas Technical Characteristics	AC14000
Carcasa Cover	ABS
Acabado Finish	Blanco / White
Pulsador/Palanca Push Button/Lever	Inox / Stainless Steel
Capacidad Volume (L)	1,000
Peso Neto Net Weight (Kg)	0,585
Peso Bruto Gross Weight (Kg)	0,715
Dosis Dose (gr)	1
Botella Extraíble Removable Bottle	X

- FIJACIÓN: 3 tornillos + 3 tacos (incluidos). | FIXING: 3 screws + 3 wall plugs (included).
- EMBALAJE: Unitario. | PACKAGING: Single.
- LIMPIEZA: Bayeta húmeda. No usar productos químicos. | CLEANING: Damp cloth. Don't use chemicals.



DOSIFICADOR JABÓN "SMART" RELLENABLE "SMART" REFILL SOAP DISPENSER

AC96000

- Dosificador rellenable ABS.
- Cerradura con llave.
- Visor de carga frontal.
- Pulsador integrado en carcasa.
- Depósito de Polietileno.
- Línea económica "Low Cost".
- Refill dispenser made of ABS.
- Key lock.
- Content viewer at the front.
- Push button integrated on cover.
- Deposit made of Polyethylene.
- Low Cost range of products.

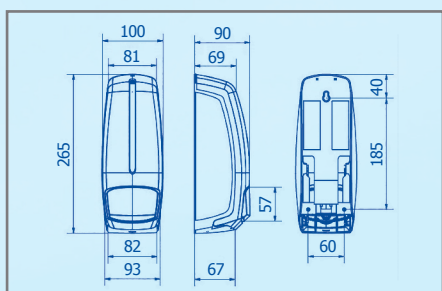

Dimensiones embalaje: (mm) 285
Packaging dimensions: 113 107

Características Técnicas Technical Characteristics		AC96000
Carcasa Cover		ABS
Acabado Finish		Blanco / White
Capacidad Volume	(L)	1,000
Peso Neto/Bruto Net/Gross Weight	(Kg)	0,330 / 0,425
Dosis Dose	(gr)	1
Jabón Soap		Líquido / Liquid

- FIJACIÓN: 3 tornillos + 3 tacos (incluidos). | FIXING: 3 screws + 3 wall plugs (included).
- EMBALAJE: Unitario. | PACKAGING: Single.
- LIMPIEZA: Bayeta húmeda. No usar productos químicos. | CLEANING: Damp cloth. Don't use chemicals.



DOSIFICADOR AUTOMÁTICO JABÓN "AZUR" RELLENABLES "AZUR" SENSOR REFILL SOAP DISPENSERS

AC91050 - AC91070

- Dosificadores rellenables ABS.
- "Non touch" higiene total.
- Cerradura con llave.
- Visor control carga.
- Programador 1, 2 o 3 dosis/servicio.
- Interruptor interior ON/OFF.
- Refill dispensers of ABS.
- Total hygiene, "Non touch" system.
- Key lock (key provided).
- Content viewer.
- Internal regulator 1, 2 or 3 doses service.
- Internal ON/OFF switch.

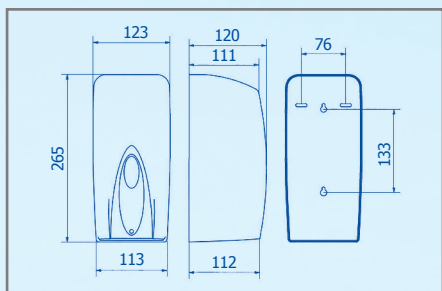

Dimensiones embalaje: (mm) 273
Packaging dimensions: 130 128



AC91050
AC91070

Características Técnicas Technical Characteristics	AC91050	AC91070
Carcasa Cover	ABS	ABS
Acabado Finish	Blanco / White	Blanco / White
Capacidad Volume	(L) 1,000	1,000
Peso Neto/Bruto Net/Gross Weight	(Kg) 0,785 / 0,895	0,785 / 0,895
Dosis Dose	(gr) 1	1
Jabón Soap	Líquido / Liquid	Spray
Duración Pilas (dosis) Batteries Life (doses)	40.000	40.000
Duración Pilas (cargas) Batteries Life (refills)	40	40

- FUNCIONAMIENTO: 6 pilas alcalinas LR6. | FUNCTIONING: 6 alkalines batteries LR6.
- FIJACIÓN: 3 tornillos + 3 tacos (incluidos).
FIXING: 3 screws + 3 wall plugs (included).

- EMBALAJE: Unitario. | PACKAGING: Single.
- LIMPIEZA: Bayeta húmeda. No usar productos químicos.
CLEANING: Damp cloth. Don't use chemicals.

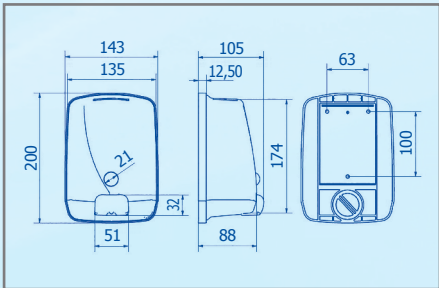

Dimensiones embalaje: (mm) 213
Packaging dimensions: 153 113

DOSIFICADOR JABÓN “FUTURA” RELLENABLES “FUTURA” REFILL SOAP DISPENSERS

AC54000 - AC54500

- Dosificadores rellenables.
- Válvula antigoteo y anticorrosión.
- Cerradura con llave.
- Visor de carga.
- Pulsador integrado en carcasa.
- Antivandálico.
- Refill dispensers.
- Non-drip and anti-corrosion valve.
- Key lock.
- Content viewer.
- Push button integrated in cover.
- Antivandalism.



AC54000

- Acero Inox Satinado Pulsador
- Satin Stainless Steel Push Button



AC54500

- Acero Inox Brillo Pulsador
- Bright Stainless Steel Push Button

Características Técnicas Technical Characteristics	AC54000	AC54500
Capacidad Volume (L)	1,000	1,000
Peso Neto Net Weight (Kg)	0,575	0,575
Peso Bruto Gross Weight (Kg)	0,665	0,665
Pulsador Push Button	ABS	ABS
Acabado Pulsador Push Button Finish	Cromado / Chromed	Cromado / Chromed
Dosis Dose (gr)	1	1

- FIJACIÓN: 3 tornillos + 3 tacos (incluidos). | FIXING: 3 screws + 3 wall plugs (included).
- EMBALAJE: Unitario. | PACKAGING: Single.
- LIMPIEZA: Bayeta húmeda. No usar productos químicos. | CLEANING: Damp cloth. Don't use chemicals.

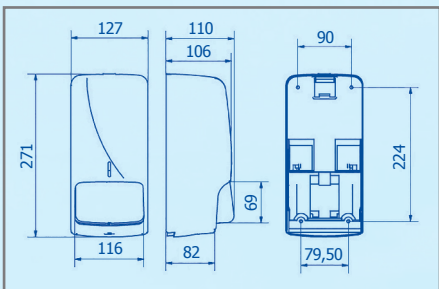

Dimensiones embalaje: (mm) 285
Packaging dimensions: 142 128

DOSIFICADOR JABÓN “FUTURA/AZUR” RELLENABLES “FUTURA/AZUR” REFILL SOAP DISPENSERS

AC53050 - AC53550 (FUTURA) / AC80050 - AC81250 - AC81450 (AZUR)

- Dosificadores rellenables.
- Válvula antigoteo y anticorrosión.
- Cerradura con llave.
- Visor de carga.
- Pulsador integrado en carcasa.
- Antivandálico.
- Refill dispensers.
- Non-drip and anti-corrosion valve.
- Key lock (key provided).
- Content viewer.
- Push button integrated in cover.
- Antivandalism.



Características Técnicas Technical Characteristics	AC53050	AC53550	AC80050	AC81250	AC81450
Carcasa Cover	Inox / S.Steel	Inox / S.Steel	ABS	SAN	SAN
Acabado Finish	Satinado / Satin	Brillo / Bright	Blanco / White	Azul / Blue	Fumé / Smoke
Base Base	ABS	ABS	ABS	ABS	ABS
Capacidad Volume (L)	0,850	0,850	0,850	0,850	0,850
Peso Neto/Bruto Net/Gross Weight (Kg)	1,020 / 1,150	1,020 / 1,150	0,620 / 0,700	0,620 / 0,700	0,620 / 0,700
Dosis Dose (gr)	1	1	1	1	1

- FIJACIÓN: 4 tornillos + 4 tacos (incluidos). | FIXING: 4 screws + 4 wall plugs (included).
- EMBALAJE: Unitario. | PACKAGING: Single.
- LIMPIEZA: Bayeta húmeda. No usar productos químicos. | CLEANING: Damp cloth. Don't use chemicals.

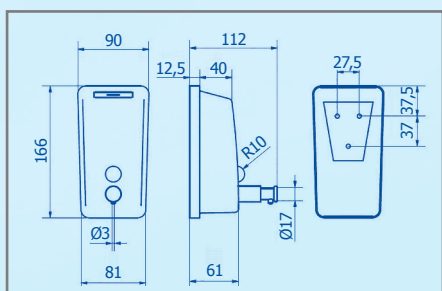

Dimensiones embalaje: (mm) 170
Packaging dimensions: 100 117

DOSIFICADOR JABÓN "CLÁSICA" VERTICAL RELLENABLES "CLASICA" REFILL SOAP DISPENSERS

ALL1006 - ALL1006B

- Dosificadores rellenables.
- Cerradura con llave.
- Visor de carga.
- Antivandálico.
- Válvula antigoteo y anticorrosión.
- Refill dispensers.
- Key lock (provided).
- Content viewer.
- Antivandalism.
- Non-drip and anti-corrosion valve.



ALL1006

- Acero Inox Satinado Pulsador
- Satin Stainless Steel Push Button



ALL1006B

- Acero Inox Brillo Pulsador
- Bright Stainless Steel Push Button

Características Técnicas Technical Characteristics	ALL1006	ALL1006B
Capacidad Volume (L)	0,500	0,500
Peso Neto Net Weight (Kg)	0,415	0,415
Peso Bruto Gross Weight (Kg)	0,485	0,485
Dosis Dose (gr)	1	1

- FIJACIÓN: 3 tornillos + 3 tacos (incluidos). | FIXING: 3 screws + 3 wall plugs (included).
- EMBALAJE: Unitario. | PACKAGING: Single.
- LIMPIEZA: Bayeta húmeda. No usar productos químicos. | CLEANING: Damp cloth. Don't use chemicals.

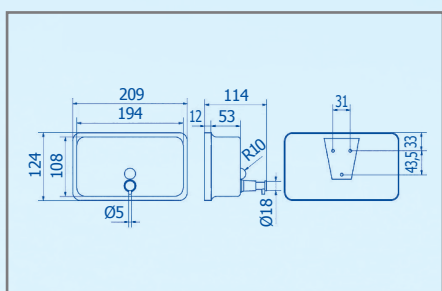

Dimensiones embalaje: (mm) 130
Packaging dimensions: 250 120

DOSIFICADOR JABÓN "CLÁSICA" HORIZONTAL RELLENABLES "CLASICA" REFILL SOAP DISPENSERS

ALL1003 - ALL1003B

- Dosificadores rellenables.
- Cerradura con llave.
- Visor de carga.
- Antivandálico.
- Válvula antigoteo y anticorrosión.
- Refill dispensers.
- Key lock.
- Content viewer.
- Antivandalism.
- Non-drip and anti-corrosion valve.



ALL1003

- Acero Inox Satinado Pulsador
- Satin Stainless Steel Push Button



ALL1003B

- Acero Inox Brillo Pulsador
- Bright Stainless Steel Push Button

Características Técnicas Technical Characteristics	ALL1003	ALL1003B
Capacidad Volume (L)	1,000	1,000
Peso Neto Net Weight (Kg)	0,495	0,495
Peso Bruto Gross Weight (Kg)	0,585	0,585
Dosis Dose (gr)	1	1

- FIJACIÓN: 3 tornillos + 3 tacos (incluidos). | FIXING: 3 screws + 3 wall plugs (included).
- EMBALAJE: Unitario. | PACKAGING: Single.
- LIMPIEZA: Bayeta húmeda. No usar productos químicos. | CLEANING: Damp cloth. Don't use chemicals.



DOSIFICADOR JABÓN "CLÁSICA" EMPOTRABLES COUNTER-MOUNTED SOAP DISPENSERS

AC62000 - AC63000

- Cabezal de latón cromado.
- Boquilla y pulsador en cabezal.
- Únicamente visible el Pulsador.
- Cabezal presionante.
- Tubo de aspiración PVC transparente (incluido).
- Lugares de alta rotación.
- Pump made of chrome plated brass.
- Pump integrated on head.
- Only the pump is visible.
- Pressing head.
- Suction tube made of transparent PVC (included).
- For places with high traffic of people.

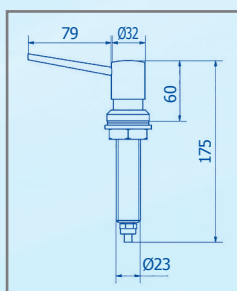

Dimensiones embalaje:
Packaging dimensions:
(mm)

215
168
268

- FIJACIÓN: Tuercas, arandelas y juntas gomas (incluidas). | FIXING: Nuts, washers and rubber seals (included).
- EMBALAJE: 5 u/caja // 2 u/caja. | PACKAGING: 5 u/pack // 2 u/pack.
- LIMPIEZA: Bayeta húmeda. No usar productos químicos. | CLEANING: Damp cloth. Don't use chemicals.



AC62000



AC63000

Características Técnicas Technical Characteristics	AC62000	AC63000
Botella Bottle	—	X
Acabado Finish	Cromado / Chromed	Cromado / Chromed
Capacidad Volume (L)	—	1,000
Peso Neto/Bruto Net/Gross Weight (Kg)	0,420 / 2,340 (5 u.)	0,530 / 1,235 (2 u.)
Long. Tubo Tube Length (m)	0,760	0,760
Ø Ext./Int. Tubo Ø Tube Ext./Inn. (mm)	8 / 6	8 / 6
Ø Agujero Min./Máx. Ø Min./Max Hole (mm)	24 / 26	24 / 26



GEL CONCENTRADO PARA ESPUMA FOAM REFILL

AT10000

- Botella de 1 L.
- Uso profesional.
- PH neutro, sin agentes agresivos.
- Producto jabón espuma.
- Embalaje 6 unidades.
- Aplicación: AC40000/45000/45500.
- 1 L bottle.
- Professional use.
- Neutral PH, aggressive agents free.
- Foam soap.
- 6 units packaging.
- Suitable for dispensers: AC40000/45000/45500.

APLICACIONES > USAGES



AZUR / FUTURA

AT10000 FOAM	→	AC40000	1 L
		AC45000	1 L
		AC45500	1 L



DOSIFICADOR "SMART" CARTUCHO "SMART" CARTRIDGE DISPENSERS AC27000 - AC27600

- Dosificadores en ABS para cartucho.
- Cerradura con llave.
- Visor de carga.
- Pulsador integrado en carcasa.
- Cartuchos de 0,800 L.
- Jabón y Gel Hidroalcohólico.
- Cartridge dispensers made of ABS.
- Key lock.
- Content viewer.
- Push button integrated in cover.
- Cartridges of 0'800 L capacity.
- Soap and Hydroalcoholic Gel.

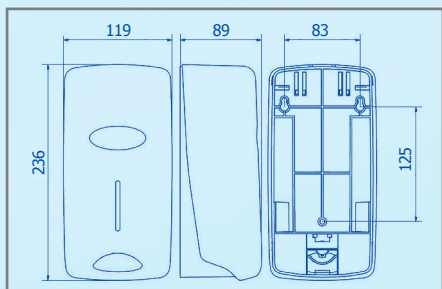

Dimensiones embalaje: (mm) 275
Packaging dimensions: 128 112

• **RECOMENDADO CARTUCHO JOFEL:**
Refs. AT52280/52380/52580/95000

• **JOFEL CARTRIDGE RECOMMENDED:**
Refs. AT52280/52380/52580/95000



AC27000

- ABS Blanco Pulsador
- White ABS Push Button



AC27600

- ABS Negro Pulsador
- Black ABS Push Button

Características Técnicas Technical Characteristics	AC27000	AC27600
Capacidad Volume (L)	0,800	0,800
Peso Neto-Bruto Net-Gross Weight (Kg)	0,305 / 0,400	0,305 / 0,400
Dosis Dose (gr)	1,03	1,03
Jabón Líquido Liquid Soap	X	X
Gel Hidroalcohólico Hydroalcoholic Gel	X	X

- FIJACIÓN: 4 tornillos + 4 tacos (incluidos). | FIXING: 4 screws + 4 wall plugs (included).
- EMBALAJE: Unitario. | PACKAGING: Single.
- LIMPIEZA: Bayeta húmeda. No usar productos químicos. | CLEANING: Damp cloth. Don't use chemicals.



DOSIFICADOR JABÓN "SMART" CARTUCHO "SMART" CARTRIDGE SOAP DISPENSER AC96500

- Carcasa ABS.
- Cerradura con llave.
- Visor de carga.
- Pulsador integrado en carcasa.
- Cartuchos de 0,800 L jabón líquido.
- Línea económica "Low Cost".
- Cover made of ABS.
- Key lock.
- Content viewer.
- Push button integrated on cover.
- Soap cartridges, 0.800 L capacity.
- Included within the "Low Cost" range of products.

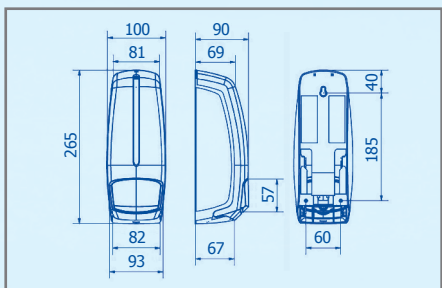

Dimensiones embalaje: (mm) 285
Packaging dimensions: 113 107

Características Técnicas Technical Characteristics	AC96500
Carcasa Cover	ABS
Acabado Finish	Blanco / White
Capacidad Volume (L)	0,800
Peso Neto-Bruto Net-Gross Weight (Kg)	0,260 / 0,340
Dosis Dose (gr)	1
Jabón Líquido Soap Liquid	X

• **CARTUCHOS:**
Refs. AT52280/52380/52580/95000

• **CARTRIDGES:**
Refs. AT52280/52380/52580/95000

- FIJACIÓN: 3 tornillos + 3 tacos (incluidos). | FIXING: 3 screws + 3 wall plugs (included).
- EMBALAJE: Unitario. | PACKAGING: Single.
- LIMPIEZA: Bayeta húmeda. No usar productos químicos. | CLEANING: Damp cloth. Don't use chemicals.



DOSIFICADOR JABÓN "AZUR / FUTURA" CARTUCHO "AZUR/FUTURA" CARTRIDGE SOAP DISPENSERS

AC41000-AC80000-AC81200-AC81400(AZUR)/AC46000-AC46500-AC53000-AC53500(FUTURA)

- Dosificador polivalente.
- Cerradura con llave.
- Visor de carga.
- Pulsador integrado.
- Cartuchos de 0,800 L.
- Según modelo: líquido, espuma, spray, higienizante o hidroalcohólico.
- Multiple uses dispensers.
- Key lock.
- Content viewer.
- Push button integrated.
- Cartridges of 0'800 L capacity.
- Depending model: liquid, foam, spray, sanitizing our hidroalcoholic.

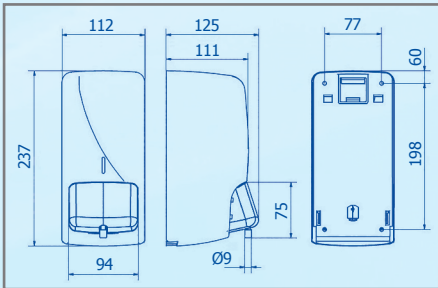

Dimensiones embalaje: (mm) 245
Packaging dimensions: 124 135

RECOMENDADO USO JABÓN JOFEL:

- Líquido** Refs. AC53*/80*/81*:
AT51280/51380/51580/96000
- Espuma** Refs. 41*/46*: AT14000
- Spray** Refs. 41*/46*: AT14500
- Espuma + Higienizante** Refs. 41*/46*:
AT14700
- Gel Hidroalcohólico** AT96000

JOFEL SOAP RECOMMENDED:

- Liquid** Refs. 53*/80*/81*:
AT51280/51380/51580/96000
- Foam** Refs. 41*/46*: AT14000
- Spray** Refs. 41*/46*: AT14500
- Foam + Sanitizing** Refs. 41*/46*:
AT14700
- Hydroalcoholic Gel** AT96000

AZUR



AC41000

- ABS Blanco Pulsador
- White ABS Push Button



AC80000

- ABS Blanco Pulsador
- White ABS Push Button



AC81200

- SAN Azul Pulsador
- Blue SAN Push Button



AC81400

- SAN Fumé Pulsador
- Smoke SAN Push Button

FUTURA



AC46000

- Acero Inox Satinado Pulsador
- Satin Stainless Steel Push Button



AC46500

- Acero Inox Brillo Pulsador
- Bright Stainless Steel Push Button



AC53000

- Acero Inox Satinado Pulsador
- Satin Stainless Steel Push Button



AC53500

- Acero Inox Brillo Pulsador
- Bright Stainless Steel Push Button

Características Técnicas Technical Characteristics		AC41000	AC80000	AC81200	AC81400	AC46000	AC46500	AC53000	AC53500
Capacidad Volume	(L)	0,800	0,800	0,800	0,800	0,800	0,800	0,800	0,800
Peso Neto Net Weight	(Kg)	0,430	0,455	0,455	0,455	0,845	0,845	0,840	0,840
Peso Bruto Gross Weight	(Kg)	0,520	0,540	0,540	0,540	0,980	0,980	0,980	0,980
Dosis Dose		1.333	800	800	800	1.455	1.455	800	800
Dosis Pulsación Dosage Pulsation	(gr)	0,6	1	1	1	0,55	0,55	1	1
Líquido Liquid		—	X	X	X	—	—	X	X
Espuma Foam		X	—	—	—	X	X	—	—
Spray Spray		X	—	—	—	X	X	—	—
Espuma + Higienizante Sanitizing + Foam		X	—	—	—	X	X	—	—
Gel Hidroalcohólico Hydroalcoholic Gel		—	X	X	X	—	—	X	X

- FIJACIÓN: 4 tornillos + 4 tacos (incluidos). | FIXING: 4 screws + 4 wall plugs (included).
- EMBALAJE: Unitario. | PACKAGING: Single.

- LIMPIEZA: Bayeta húmeda. No usar productos químicos. | CLEANING: Damp cloth. Don't use chemicals.



DOSIFICADOR AUTOMÁTICO JABÓN "AZUR" CARTUCHO "AZUR" CARTRIDGE SOAP SENSOR DISPENSER AC91000

- Carcasa ABS.
- Cerradura con llave.
- "Non touch": higiene total.
- Programador 1, 2 o 3 dosis/servicio.
- Interruptor ON/OFF interior.
- Visor de carga.

- Cover made of ABS.
- Key lock.
- Total hygiene: "Non touch" system.
- Dose regulator: 1, 2 or 3 doses per service.
- Internal ON/OFF switch.
- Content viewer.

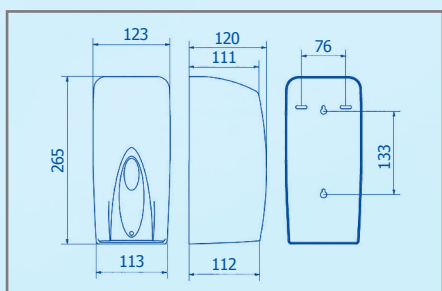

Dimensiones embalaje: (mm) 273
Packaging dimensions: 130 128

Características Técnicas | Technical Characteristics

Carcasa | Cover
Acabado | Finish
Capacidad | Volume (L)
Peso Neto-Bruto | Net-Gross Weight (Kg)
Duración Pilas (dosis) | Batteries Life (doses)
Duración Pilas (cargas) | Batteries Life (refills)

AC91000

ABS
Blanco / White
0,800
0,716 / 0,829
4.000
40
Líquido - Espuma - Spray - Higienizante /
Liquid - Foam - Spray - Sanitizing

Jabón | Soap

• CARTUCHOS:

Líquido: Refs. AT53280/53380/53580
Espuma: Ref. AT16000
Spray: Ref. AT16500
Espuma + Higienizante: Ref. AT16700

• CARTRIDGES:

Liquid Refs. AT53280/53380/53580
Foam Ref. AT16000
Spray Ref. AT16500
Foam + Sanitizing Ref. AT16700

- FUNCIONAMIENTO: 6 pilas alcalinas LR6. | FUNCTIONING: 6 alkalines batteries LR6.
- FIJACIÓN: 3 tornillos + 3 tacos (incluidos). | FIXING: 3 screws + 3 wall plugs (included).
- EMBALAJE: Unitario. | PACKAGING: Single.
- LIMPIEZA: Bayeta húmeda. No usar productos químicos. | CLEANING: Damp cloth. Don't use chemicals.

APLICACIONES CARTUCHOS JABÓN > CARTRIDGE SOAP USAGES



AZUR / FUTURA

AT14000 FOAM	→	AC41000	0,80 L
AT14500 SPRAY	→	AC46000	0,80 L
AT14700 FOAM	→	AC46500	0,80 L



AZUR / FUTURA

AT51280 GEL	→	AC53000	0,80 L
AT51380 GEL	→	AC53500	0,80 L
AT51580 GEL	→	AC80000	0,80 L
AT96000 HYDROALC.	→	AC81200	0,80 L
	→	AC81400	0,80 L



AZUR

AT16000 FOAM	→	AC91000	0,80 L
AT16500 SPRAY	→		
AT16700 FOAM	→		



AZUR

AT53280 GEL	→	AC91000	0,80 L
AT53380 GEL	→		
AT53580 GEL	→		



SMART

AT52280 GEL	→		
AT52380 GEL	→	AC96500	0,80 L
AT52580 GEL	→	AC27000	0,80 L
AT95000 HYDROALC.	→		



CARTUCHO CONCENTRADO PARA ESPUMA CONCENTRATED FOAM CARTRIDGE

AT14000

- Bolsa de 0,800 L
- Válvula incorporada.
- PH neutro, sin agentes agresivos.
- Dosis 0,6 ml (1.333 dosificaciones).
- Embalaje 6 unidades.
- Aplicación: AC41000/46000/46500.
- 0.800 L cartridge
- Pump integrated
- Neutral PH, aggressive agents free
- 0.6 ml per dose (1.333 dosages)
- Packaging: 6 units
- Suitable for: AC41000/46000/46500.



CARTUCHO JABÓN PARA SPRAY SPRAY CARTRIDGE

AT14500

- Bolsa de 0,800 L
- Válvula incorporada.
- PH neutro, sin agentes agresivos.
- Dosis 0,6 ml (1.333 dosificaciones).
- Embalaje 6 unidades.
- Aplicación: AC41000/46000/46500.
- 0.800 L cartridge
- Pump integrated
- Neutral PH, aggressive agents free
- 0.6 ml per dose (1.333 dosages)
- Packaging: 6 units
- Suitable for: AC41000/46000/46500.



CARTUCHO JABÓN ESPUMA HIGIENIZANTE SANITIZING FOAM CARTRIDGE

AT14700

- Bolsa de 0,800 L.
- Válvula incorporada.
- PH neutro, sin agentes agresivos.
- Dosis 0,6 ml (1.333 dosificaciones).
- Incorpora triclosán (antibacteriano y fungicida).
- Embalaje 6 unidades.
- Aplicación: AC41000/46000/46500.
- 0'800 L cartridge.
- Pump integrated.
- Neutral PH, aggressive agents free.
- 0.6 ml per dose (1.333 dosages).
- Includes triclosan (antebacterial and antifungal).
- 6 units packaging.
- Suitable for AC41000/46000/46500.



CARTUCHO JABÓN ESPUMA FOAM CARTRIDGE

AT16000

- Bolsa de 0,800 L.
- Válvula incorporada.
- PH neutro, sin agentes agresivos.
- Dosis 0,375 ml (2.150 dosificaciones).
- Embalaje 6 unidades.
- Aplicación: AC91000
- 0'800 L cartridge.
- Pump integrated.
- Neutral PH, aggressive agents free.
- 0.375 ml per dose (2.150 dosages).
- 6 units packaging.
- Suitable for AC91000.



CARTUCHO JABÓN SPRAY SPRAY CARTRIDGE

AT16500

- Bolsa de 0,800 L.
- Válvula incorporada.
- PH neutro, sin agentes agresivos.
- Dosis 0,375 ml (2.150 dosificaciones).
- Embalaje 6 unidades.
- Aplicación: AC91000.
- 0'800 L cartridges.
- Pump integrated.
- Neutral PH, aggressive agents free.
- 0.375 ml per dose (2,150 dosages).
- 6 units packaging.
- Suitable for AC91000.



CARTUCHO JABÓN ESPUMA HIGIENIZANTE SANITIZING FOAM CARTRIDGE

AT16700

- Bolsa de 0,800 L.
- Válvula incorporada.
- PH neutro, sin agentes agresivos.
- Dosis 0,375 ml (2.150 dosificaciones).
- Incorpora triclosán (antibacteriano y fungicida).
- Embalaje 6 unidades.
- Aplicación: AC91000.

- 0'800 L cartridges.
- Pump integrated.
- Neutral PH, aggressive agents free.
- 0.375 ml per dose (2.150 dosages).
- Includes triclosan (antibacterial and antifungal).
- 6 units packaging.
- Suitable for AC91000.



GEL DERMOPROTECTOR PREMIUM (NÁCAR) PREMIUM DERMOPROTECTOR GEL (PEARL)

AT51280

- Cartucho gel enriquecido de 0,800 L, Universal.
- Se instalan con su envase cartón.
- Válvula incorporada.
- Dosis 1 gr (800 dosificaciones).
- PH neutro, sin agentes agresivos.
- Embalaje 12 unidades.
- Aplicación:
AC53000/53500/80000/81200/81400.

- Enriched gel soap, 0.800 L, universal.
- Cartridges installed with box.
- Pump integrated.
- 1 gr per dose (800 dosages).
- Neutral PH, aggressive agents free.
- Packaging: 12 units .
- Suitable for
AC53000/53500/80000/81200/81400.



GEL HOSTELERÍA LUJO (AZUL) DELUXE HOSTELRY GEL (BLUE)

AT51380

- Cartucho gel concentrado mejorado de 0,800 L, Universal.
- Se instalan con su envase cartón.
- Válvula incorporada.
- Dosis 1 gr (800 dosificaciones).
- PH neutro, sin agentes agresivos.
- Embalaje 12 unidades.
- Aplicación:
AC53000/53500/80000/81200/81400.

- Concentrated gel soap, improved formula, 0.800 L, universal.
- Installed with box.
- Pump integrated.
- 1 gr per dose (800 dosages).
- Neutral PH, aggressive agents free.
- Packaging: 12 units.
- Suitable for
AC53000/53500/80000/81200/81400.



GEL HOSTELERÍA STANDARD (ROJO) STANDARD HOSTELRY GEL (RED)

AT51580

- Cartucho gel concentrado de 0,800 L, Universal.
- Se instalan con su envase cartón.
- Válvula incorporada.
- Dosis 1 gr (800 dosificaciones).
- PH neutro, sin agentes agresivos.
- Embalaje 12 unidades.
- Aplicación:
AC53000/53500/80000/81200/81400.

- Concentrated gel cartridge, 0.800 L, universal.
- Cartridges installed with box.
- Pump integrated.
- 1 gr per dose (800 dosages).
- Neutral PH, aggressive agents free.
- Packaging: 12 units.
- Suitable for:
AC53000/53500/80000/81200/81400.



GEL DERMOPROTECTOR PREMIUM (NÁCAR) PREMIUM DERMOPROTECTOR GEL (PEARL) AT52280

- Cartucho gel enriquecido de 0,800 L.
 - Válvula incorporada. Dosis 1 gr. (800 dosificaciones).
 - PH neutro, sin agentes agresivos.
 - Se instala sin envase.
 - Embalaje 12 unidades.
 - Aplicación: AC27000/27600/96500.
- Concentrated gel cartridge, 0.800 L capacity.
 - Pump integrated. 1gr per dose (800 dosages).
 - Neutral PH, aggressive agents free.
 - Installed without packaging.
 - Packaging: 12 units.
 - Suitable for AC27000/27600/96500.



GEL HOSTELERÍA LUJO (AZUL) DELUXE HOSTELRY GEL (BLUE) AT52380

- Cartucho gel concentrado mejorado de 0,800 L, Universal.
 - Se instalan sin envase.
 - Válvula incorporada. Dosis 1 gr (800 dosificaciones).
 - PH neutro, sin agentes agresivos.
 - Embalaje 12 unidades.
 - Aplicación: AC27000/27600/96500.
- Concentrated gel cartridge, improved formula, 0.800 L capacity.
 - Installed without packaging.
 - Pump integrated. 1 gr per dose (800 dosages).
 - Neutral PH, aggressive agents free.
 - Packaging: 12 units.
 - Suitable for AC27000/27600/96500.



GEL HOSTELERÍA STANDARD (ROJO) STANDARD HOSTELRY GEL (RED) AT52580

- Cartucho gel concentrado de 0,800 L.
 - Se instala sin envase.
 - Válvula incorporada. Dosis 1 gr (800 dosificaciones).
 - PH neutro, sin agentes agresivos.
 - Embalaje 12 unidades.
 - Aplicación: AC27000/27600/96500.
- Concentrated gel cartridge, 0.800 L capacity.
 - Installed without packaging.
 - Pump integrated. 1 gr per dose (800 dosages).
 - Neutral PH, aggressive agents free.
 - Packaging: 12 units .
 - Suitable for AC27000/27600/96500.



GEL DERMOPROTECTOR PREMIUM (NÁCAR) PREMIUM DERMOPROTECTOR GEL (PEARL) AT53280

- Cartucho gel enriquecido de 0,800 L.
 - Válvula incorporada. Dosis 1 gr (800 dosificaciones).
 - PH neutro, sin agentes agresivos.
 - Se instala sin envase.
 - Embalaje 12 unidades.
 - Aplicación: AC91000.
- Enriched gel cartridge, 0.800 L capacity.
 - Pump integrated. 1 gr per dose (800 dosages).
 - Neutral PH, aggressive agents free.
 - Installed without packaging.
 - Packaging: 12 units.
 - Suitable for AC91000.



GEL HOSTELERÍA LUJO (AZUL) DELUXE HOSTELLERY GEL (BLUE)

AT53380

- Cartucho gel concentrado de 0,800 L.
 - Válvula incorporada. Dosis 1gr (800 dosificaciones).
 - PH neutro, sin agentes agresivos.
 - Se instala sin envase.
 - Embalaje: 12 unidades.
 - Aplicación: AC91000.
- Concentrated gel cartridge, 0.800 L capacity.
 - Pump integrated. 1 gr per dose (800 dosages).
 - Neutral PH, aggressive agents free.
 - Installed without packaging.
 - Packaging: 12 units.
 - Suitable for AC91000.



GEL HOSTELERÍA STANDARD (ROJO) STANDARD HOSTELLERY GEL (RED)

AT53580

- Cartucho gel concentrado de 0,800 L.
 - Válvula incorporada. Dosis 1gr (800 dosificaciones).
 - PH neutro, sin agentes agresivos.
 - Se instala sin envase.
 - Embalaje 12 unidades.
 - Aplicación: AC91000.
- Concentrated gel cartridge, 0.800 L capacity.
 - Pump integrated. 1 gr per dose (800 dosages).
 - Neutral PH, aggressive agents free.
 - Installed without packaging.
 - Packaging: 12 units.
 - Suitable for AC91000.



GEL HIDROALCOHÓLICO HYDROALCOHOLIC GEL

AT95000

- Cartucho gel concentrado de 0,800 L.
 - Válvula incorporada y desechable.
 - Incoloro e inodoro.
 - Alto poder antibacteriano.
 - Dosis 1 gr.
 - Ausencia de perfume
 - Cartuchos de 800 servicios.
 - Embalaje: 12 unidades.
 - Aplicación: AC27000/27600/96500.
- Cartridge, 0.800 L.
 - Valve incorporated and disposable.
 - Odourless and colourless.
 - High antibacterial properties.
 - Doses: 1 gr.
 - No perfum.
 - Each cartridge delivers 800 services.
 - Packaging: 12 units.
 - Application: AC27000/26500/96500.



GEL HIDROALCOHÓLICO HYDROALCOHOLIC GEL

AT96000

- Cartucho gel concentrado de 0,800 L.
 - Válvula incorporada y desechable.
 - Incoloro e inodoro.
 - Alto poder antibacteriano.
 - Dosis 1 gr.
 - Ausencia de perfume
 - Cartuchos de 800 servicios.
 - Embalaje: 12 unidades.
 - Aplicación: AC53000/53500/80000/81200/81400.
- Cartridge, 0.800 L.
 - Valve incorporated and disposable.
 - Odourless and colourless.
 - High antibacterial properties.
 - Doses: 1 gr.
 - No perfum.
 - Each cartridge delivers 800 services.
 - Packaging: 12 units.
 - Application: AC53000/53500/80000/81200/81400.



PORTABOBINAS MURAL INDUSTRIAL ROLL DISPENSER, WALL AD10000

- Totalmente metálico.
- Chasis tubo acero Ø 20 mm.
- Sierra metálica de 1 mm espesor.
- Bobinas hasta 500 m.
- Mandriles Ø 60/70 mm.
- Pintura electrostática Poliéster.
- Entirely metallic.
- Frame made of steel tube with diameter of 20 mm.
- Serrated metal cutter, 1 mm thick.
- Rolls up to 500 m.
- Mandrels of Ø 60/70 mm.
- Polyester electrostatic paint.

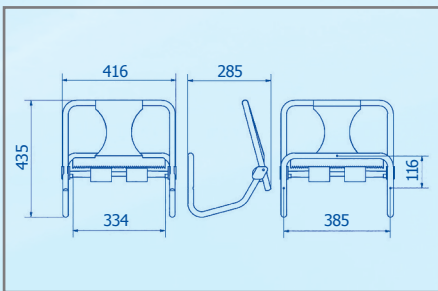

Dimensiones embalaje: (mm) 310
Packaging dimensions: 465 460

Características Técnicas Technical Characteristics	AD10000
Chasis Frame	Acero / Steel
Acabado Finish	Pintado Poliéster / Polyester Painted
Peso Neto Net Weight (Kg)	1,710
Peso Bruto Gross Weight (Kg)	9,360 (5 u.)
Bobina Long. Máx. Max. Length Jumbo Roll (m)	500
Bobina Ø Máx. Max. Ø Jumbo Roll (mm)	480
Bobina Ancho Máx. Jumbo Roll Max. Width (mm)	320
Mandril Ø Bobina Jumbo Roll Ø Mandrel (mm)	60 - 70

- FIJACIÓN: 3 tornillos + 3 tacos (incluidos). | FIXING: 3 screws + 3 wall plugs (included).
- EMBALAJE: 5 u. | PACKAGING: 5 u.
- LIMPIEZA: Bayeta húmeda. No usar productos químicos. | CLEANING: Damp cloth. Don't use chemicals.



PORTABOBINAS SUELO INDUSTRIAL ROLL DISPENSER, STANDING AD30000

- Totalmente metálico y plegable.
- Chasis tubo acero Ø 20 mm.
- Sierra metálica de 1 mm espesor.
- Bobinas hasta 500 m.
- Mandriles Ø 60 / 70 mm.
- Pintura electrostática Poliéster.
- Entirely metallic, folding.
- Frame made of steel tube of Ø 20 mm.
- Serrated metal cutter, 1mm thick
- Rolls up to 500 m.
- Mandrels of Ø 60/70 mm.
- Polyester electrostatic paint.

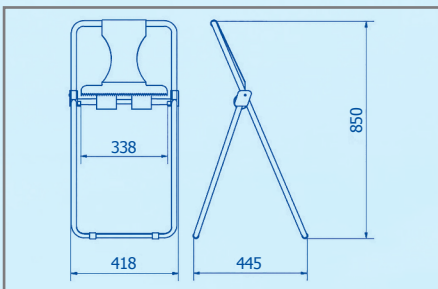

Dimensiones embalaje: (mm) 928
Packaging dimensions: 420 308

Características Técnicas Technical Characteristics	AD30000
Chasis Frame	Acero / Steel
Acabado Finish	Pintado Poliéster / Polyester Painted
Peso Neto Net Weight (Kg)	2,935
Peso Bruto Gross Weight (Kg)	12,650 (5 u.)
Bobina Long. Máx. Max. Length Jumbo Roll (m)	500
Bobina Ø Máx. Max. Ø Jumbo Roll (mm)	480
Bobina Ancho Máx. Jumbo Roll Max. Width (mm)	320
Mandril Ø Bobina Jumbo Roll Ø Mandrel (mm)	60 - 70

- FIJACIÓN: Base con tacos de goma antideslizantes. | FIXING: Anti-slip rubber pads on base.
- EMBALAJE: 5 u. | PACKAGING: 5 u.
- LIMPIEZA: Bayeta húmeda. No usar productos químicos. | CLEANING: Damp cloth. Don't use chemicals.



PORTARROLLOS “CLÁSICA” “CLASICA” JUMBO TOILET ROLL DISPENSERS

AE12100 - AE12150 - AE12400 - AE13300 (EPOXY) / AE21000 - AE23000 - AE24300 (INOX)

- Dispensadores papel rollo continuo.
- Cerradura con llave.
- Visor de carga.
- Antivandálico.
- Apertura abatible frontal.
- Admite mandriles Ø 18 a 55 mm.
- Jumbo toilet tissue dispenser.
- Key lock.
- Level indicator.
- Antivandalism.
- Reclining front cover.
- Suitable for mandrels from Ø 18 to 55 mm.

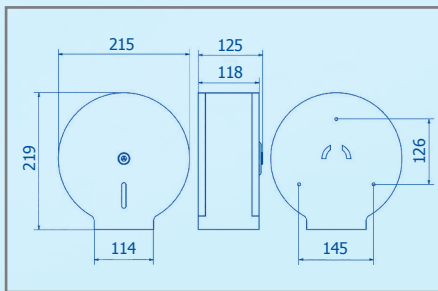

Dimensiones embalaje: (mm) 285
Packaging dimensions: 255 130

EJES / CORES



RE2001
Ø18 mm



RE2002
Ø45 mm



RE2003
Ø55 mm

EPOXY



AE12100

- Acero Poliéster Blanco
- Steel Polyester White



AE12150

- Acero Poliéster Blanco
- Steel Polyester White



AE12400

- Acero Poliéster Blanco
- Steel Polyester White



AE13300

- Acero Poliéster Blanco
- Steel Polyester White

INOX / STAINLESS STEEL



AE21000

- Acero Inox Satinado
- Satin Stainless Steel



AE23000

- Acero Inox Satinado
- Satin Stainless Steel



AE24300

- Acero Inox Satinado
- Satin Stainless Steel

Características Técnicas Technical Characteristics	AE12100	AE12150	AE12400	AE13300	AE21000	AE23000	AE24300
Peso Neto Net Weight (Kg)	1,390	1,415	1,135	1,795	1,380	1,055	1,635
Peso Bruto Gross Weight (Kg)	1,525	1,555	1,300	1,985	1,515	1,235	1,830
Bobina Long. Máx. Max. Length Jumbo Roll (m)	300	300	200	400	300	200	400
Bobina Ø Máx. Max. Ø Jumbo Roll (mm)	220	220	190	260	220	190	260
Bobina Ancho Máx. Jumbo Roll Max. Width (mm)	90	90	90	90	90	90	90
Mandril Ø Bobina Jumbo Roll Ø Mandrel (mm)	18 / 45 / 55	18 / 45 / 55	18 / 45 / 55	18 / 45 / 55	18 / 45 / 55	18 / 45 / 55	18 / 45 / 55
Cenicero Ashtray	—	X	—	—	—	—	—

• FIJACIÓN: 3 tornillos + 3 tacos (incluidos). | FIXING: 3 screws + 3 wall plugs (included).
• EMBALAJE: Unitario. | PACKAGING: Single.

• LIMPIEZA: Bayeta húmeda. No usar productos químicos
CLEANING: Damp cloth. Don't use chemicals.



PORTARROLLOS "AZUR" ABS "AZUR" ABS JUMBO ROLL DISPENSERS

AE51000 / AE51050 / AE51700 / AE52200 / AE52400 / AE53060 / AE55000
AE55300 / AE56000 / AE56300 / AE58300 / AE58500

- Dispensadores papel rollo continuo.
- Cerradura con llave.
- Visor de carga.
- Apertura frontal abatible.
- Opciones acabados: Blanco, Fumé, Negro, Azul, Níquel.
- Tratamiento antibacteriano (AE51700).
- Jumbo toilet tissue dispensers.
- Key lock.
- Level indicator.
- Reclining front cover.
- Different finishes available: White, Smoked, Black, Blue, Nickel.
- (AE51700) Antibacterial treatment.

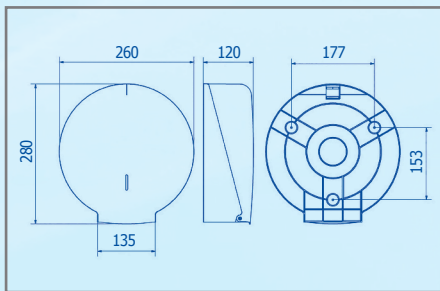

Dimensiones embalaje: (mm) 284
Packaging dimensions: 275 131



AE51000

- ABS Blanco
- White ABS



AE51050

- ABS Blanco
- White ABS



AE51700

- ABS Antibac Blanco
- Antibac ABS White



AE52200

- SAN Azul
- Blue SAN

ADAPTADORES / ADAPTERS



RE2004
Ø 45/55 mm



AE52400

- SAN Fumé
- Smoke SAN



AE53060

- ABS Blanco
- White ABS



AE55000

- ABS Blanco
- White ABS



AE55300

- ABS Blanco
- White ABS



RE2005
Ø 55/70 mm



AE56000

- SAN Fumé
- Smoke SAN



AE56300

- SAN Fumé
- Smoke SAN



AE58300

- ABS Níquelado
- Nickeled ABS



AE58500

- ABS Níquelado
- Nickeled ABS

Características Técnicas Technical Characteristics		AE51000	AE51050	AE51700	AE52200	AE52400	AE53060	AE55000	AE55300	AE56000	AE56300	AE58300	AE58500
Peso Neto Net Weight	(Kg)	0,670	0,700	0,670	0,665	0,665	1,050	0,840	0,865	0,825	0,865	0,770	0,840
Peso Bruto Gross Weight	(Kg)	0,795	0,830	0,795	0,790	0,790	2,555 (2u)	0,990	1,020	0,985	1,020	0,815	0,990
Bobina Long. Máx. Max. Length Jumbo Roll	(m)	300	300	300	300	300	500	400	400	400	400	300	500
Bobina Ø Máx. Max. Ø Jumbo Roll	(mm)	220	220	220	220	220	310	260	260	260	260	220	310
Bobina Ancho Máx. Jumbo Roll Max. Width	(mm)	90	90	90	90	90	90	90	90	90	90	90	90
Mandril Ø Bobina Jumbo Roll Ø Mandrel	(mm)	45	45	45	45	45	55	45	55	45	55	45	45
Cenicero Ashtray		—	X	—	—	—	—	—	—	—	—	—	—
Antibacteriano Antibacterial		—	—	X	—	—	—	—	—	—	—	—	—

- FIJACIÓN: 3 tornillos + 3 tacos (incluidos). | FIXING: 3 screws + 3 wall plugs (included).
- EMBALAJE: Unitario. | PACKAGING: Single.

- LIMPIEZA: Bayeta húmeda. No usar productos químicos. | CLEANING: Damp cloth. Don't use chemicals.

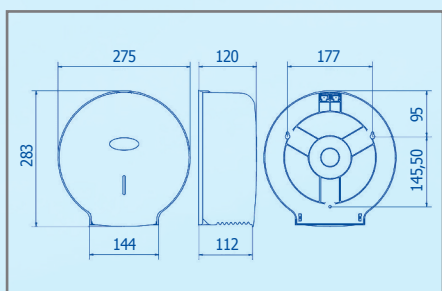

Dimensiones embalaje: (mm) 280
Packaging dimensions: 275 130

PORTARROLLOS "SMART" ABS "SMART" ABS JUMBO TOILET ROLL DISPENSERS AE57000 / AE57600 / AE77000

- Dispensadores ABS papel rollo continuo.
- Cerradura con llave y visor de carga.
- Línea económica "Low Cost".
- Apertura frontal abatible.
- Toilet tissue dispensers, made of ABS.
- Key lock, content viewer.
- "Low Cost" range of products.
- Reclining front cover.



AE57000



AE57600



AE77000

Características Técnicas Technical Characteristics	AE57000	AE57600	AE77000
Carcasa Cover	ABS	ABS	ABS
Acabado Finish	Blanco / White	Negro / Black	Blanco / White
Peso Neto/Bruto Net/Gross Weight (Kg)	0,460 / 0,605	0,460 / 0,605	0,620 / 0,770
Bobina Long. Máx. Max. Length Jumbo Roll (m)	300	300	400
Bobina Ø Máx. Max. Ø Jumbo Roll (mm)	220	220	260
Bobina Ancho Máx. Jumbo Roll Max. Width (mm)	90	90	90
Mandril Ø Bobina Jumbo Roll Ø Mandrel (mm)	45	45	45-55

- FIJACIÓN: 3 tornillos + 3 tacos (incluidos). | FIXING: 3 screws + 3 wall plugs (included).
- EMBALAJE: Unitario. | PACKAGING: Single.
- LIMPIEZA: Bayeta húmeda. No usar productos químicos. | CLEANING: Damp cloth. Don't use chemicals.

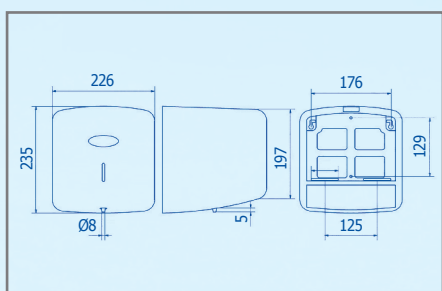

Dimensiones embalaje: (mm) 241
Packaging dimensions: 236 236

PORTARROLLOS HORIZONTAL "SMART" ABS "SMART" ABS JUMBO CENTREFEED TOILET DISPENSERS AE67000 / AE67400 / AE67600

- Dispensadores papel continuo por la base.
- Línea económica "Low Cost".
- Apertura frontal abatible.
- Sistema de "estrangulamiento" papel.
- Centrefeed toilet tissue dispensers.
- Included on the "Low Cost" range of products.
- Reclining front cover.
- Paper "Strangulation" system.



AE67000



AE67400



AE67600

Características Técnicas Technical Characteristics	AE67000	AE67400	AE67600
Carcasa Cover	ABS	SAN	ABS
Base Base	ABS Blanco / White ABS	ABS Blanco / White ABS	ABS Negro / Black ABS
Acabado Finish	Blanco / White	Fumé / Smoke	Negro / Black
Peso Neto/Bruto Net/Gross Weight (Kg)	0,660 / 0,860	0,660 / 0,860	0,660 / 0,860
Bobina Long. Máx. Max. Length Jumbo Roll (m)	300	300	300
Bobina Ø Máx. Max. Ø Jumbo Roll (mm)	210	210	210
Bobina Ancho Máx. Jumbo Roll Max. Width (mm)	130	130	130

- FIJACIÓN: 3 tornillos + 3 tacos (incluidos). | FIXING: 3 screws + 3 wall plugs (included).
- EMBALAJE: Unitario. | PACKAGING: Single.
- LIMPIEZA: Bayeta húmeda. No usar productos químicos. | CLEANING: Damp cloth. Don't use chemicals.



PORTARROLLOS INDUSTRIAL "FUTURA" INOX "FUTURA" S. STEEL JUMBO TOILET ROLL DISPENSER AE25000 / AE25500 / AE26000 / AE26500

- Dispensadores papel continuo.
- Cerradura con llave.
- Antivandálico.
- Apertura frontal abatible.
- Jumbo toilet roll dispensers.
- Key lock.
- Antivandalism.
- Reclining front cover.

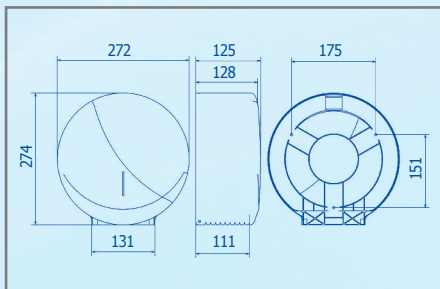

Dimensiones embalaje: (mm) 285
Packaging dimensions: 278 140



AE25000



AE25500



AE26000



AE26500

Características Técnicas Technical Characteristics	AE25000	AE25500	AE26000	AE26500
Carcasa Cover	Inox / S.Steel	Inox / S.Steel	Inox / S.Steel	Inox / S.Steel
Acabado Finish	Satinado / Satin	Brillo / Bright	Satinado / Satin	Brillo / Bright
Peso Neto/Bruto Net/Gross Weight (Kg)	0,985 / 1,185	0,985 / 1,185	1,305 / 1,580	1,305 / 1,580
Bobina Long. Máx. Max. Length Jumbo Roll (m)	300	300	400	400
Bobina Ø Máx. Max. Ø Jumbo Roll (mm)	220	220	260	260
Bobina Ancho Máx. Jumbo Roll Max. Width (mm)	90	90	90	90
Mandril Ø Bobina Jumbo Roll Ø Mandrel (mm)	45	45	55	55

- FIJACIÓN: 3 tornillos + 3 tacos (incluidos). | FIXING: 3 screws + 3 wall plugs (included).
- EMBALAJE: Unitario. | PACKAGING: Single.
- LIMPIEZA: Bayeta húmeda. No usar productos químicos. | CLEANING: Damp cloth. Don't use chemicals.

ACCESORIOS PARA PORTARROLLOS > ACCESSORIES FOR JUMBO ROLL DISPENSERS

MANDRILES Y ADAPTADORES PARA EJES PORTARROLLOS ACCESSORIES FOR JUMBO ROLL DISPENSERS

RE2001 - RE2002 - RE2003 (EJES/CORES) / RE2004 - RE2005 (ADAPTADORES/ADAPTERS)

- Fabricados en ABS gris.
- Se incorporan a los ejes de los aparatos.
- Perfecta adecuación al mandril.
- Resistentes y duraderos.
- Fácilmente manipulables.
- Se pueden desmontar y cambiar.

- Made of grey ABS.
- To be incorporated to axis of devices.
- Fits mandrel perfectly.
- Sturdy, long lasting life.
- Easy to handle.
- They can be disassembled and changed.

EJES / CORES



RE2001



RE2002



RE2003

ADAPTADORES / ADAPTERS



RE2004



RE2005

APLICACIONES / USAGES	REF.	EJE Ø mm / CORE Ø mm	APARATOS / APPLIANCES
	RE2001	18	AE: 12*-13*-21*-23*-24*
	RE2002	45	AE: 12*-13*-21*-23*-24*
	RE2003	55	AE: 12*-13*-21*-23*-24*
	RE2004	45/55	AE* (todos/all)
	RE2005	55/70	AE* (todos/all)

- EMBALAJE: Según pedido. | PACKAGING: On request.

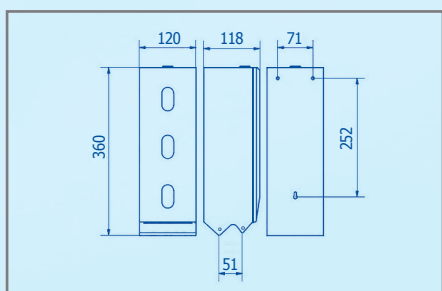

Dimensiones embalaje: (mm) 425
Packaging dimensions: 365 260

PORTARROLLOS DOBLE/TRIPLE DOMÉSTICOS "CLÁSICA" METÁLICA "CLASICA" METAL DOMESTIC TOILET ROLL DISPENSERS AF11000 - AF12000 (INOX) / AF21000 - AF22000 (EPOXY)

- Dispensadores rollo papel higiénico doméstico.
- Según modelo: 2 o 3 rollos.
- Cerradura con llave.
- Visor de carga y frontal abatible.
- Los rollos se sitúan automáticamente.
- Antivandálico.
- Standard toilet tissue roll dispensers.
- Available for 2 or 3 rolls.
- Key lock.
- Level indicator, reclining front cover.
- Rolls adjusted automatically.
- Antivandalism.

INOX / S.STEEL



AF11000



AF12000

EPOXY



AF21000



AF22000

Características Técnicas Technical Characteristics	AF11000	AF12000	AF21000	AF22000
Carcasa Cover	Inox / S.Steel	Inox / S.Steel	Acero / Steel	Acero / Steel
Acabado Finish	Satinado / Satin	Satinado / Satin	Poliéster Blanco White Polyester	Poliéster Blanco White Polyester
Peso Neto/Bruto Net/Gross Weight (Kg)	1,300/8,500 (6u)	0,995/9,645 (9u)	1,410/9,030 (6u)	1,195/11,455 (9u)
Nº Rollos Rolls	3	2	3	2

- FIJACIÓN: 3 tornillos + 3 tacos (incluidos). | FIXING: 3 screws + 3 wall plug (included).
- EMBALAJE: Unitario. | PACKAGING: Single.
- LIMPIEZA: Bayeta húmeda. No usar productos químicos. | CLEANING: Damp cloth. Don't use chemicals.

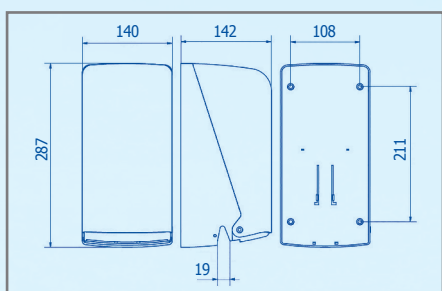

Dimensiones embalaje: (mm) 293
Packaging dimensions: 145 145

PORTARROLLOS DOBLE DOMÉSTICOS "AZUR" ABS "AZUR" ABS DOMESTIC TOILET ROLL DISPENSERS AF50000 - AF51200 - AF51400

- Dispensadores rollo papel higiénico doméstico.
- Cerradura con llave.
- Visión de carga de papel.
- Frontal abatible.
- Carga 2 rollos.
- Los rollos se sitúan automáticamente.
- Standard toilet tissue roll dispensers.
- Key lock.
- Level indicator.
- Reclining front cover.
- Accomodates 2 rolls.
- Rolls are adjusted automatically.



AF50000



AF51200



AF51400

Características Técnicas Technical Characteristics	AF50000	AF51200	AF51400
Carcasa Cover	ABS	SAN	SAN
Base Base	ABS Blanco / White ABS	ABS Blanco / White ABS	ABS Blanco / White ABS
Acabado Finish	Blanco / White	Azul / Blue	Fumé / Smoke
Peso Neto/Bruto Net/Gross Weight (Kg)	0,580 / 0,670	0,580 / 0,670	0,580 / 0,670

- FIJACIÓN: 4 tornillos + 4 tacos (incluidos). | FIXING: 4 screws + 4 plugs (included).
- EMBALAJE: Unitario. | PACKAGING: Single.
- LIMPIEZA: Bayeta húmeda. No usar productos químicos. | CLEANING: Damp cloth. Don't use chemicals.



PORTARROLLOS DOBLE DOMÉSTICOS "FUTURA" INOX "FUTURA" S. STEEL DOMESTIC TOILET ROLL DISPENSERS AF55000 - AF55500

- Dispensadores papel higiénico doméstico.
- Frontal abatible.
- Cerradura con llave.
- Visor de carga.
- Antivandálico.
- Los rollos se sitúan automáticamente.

- Standard toilet tissue roll dispensers.
- Reclining cover.
- Key lock.
- Level indicator.
- Antivandalism.
- Rolls are placed automatically.

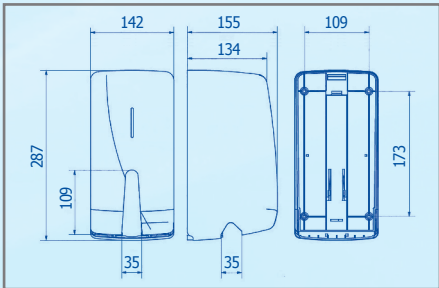

Dimensiones embalaje: (mm) 292
Packaging dimensions: 145 157



AF55000

- Acero Inox Satinado
- Satin Stainless Steel



AF55500

- Acero Inox Brillo
- Bright Stainless Steel

Características Técnicas Technical Characteristics	AF55000	AF55500
Peso Neto Net Weight (Kg)	1,090	1,090
Peso Bruto Gross Weight (Kg)	1,250	1,250
Nº Rollos Rolls	2	2

- FIJACIÓN: 4 tornillos + 4 tacos (incluidos). | FIXING: 4 screws + 4 plugs (included).
- EMBALAJE: Unitario. | PACKAGING: Single.
- LIMPIEZA: Bayeta húmeda. No usar productos químicos. | CLEANING: Damp cloth. Don't use chemicals.

DISPENSADORES COMBI > COMBI DISPENSERS



DISPENSADORES COMBI "AZUR" "AZUR" TOWEL ROLL AND FOLD COMBI DISPENSERS AH45000 - AH46000

- Dispensan toallas Z o rollo papel.
- Cerradura con llave.
- Versátil por opciones y acabado.
- Doble opción: buen servicio asegurado.
- Recarga rápida y fácil.
- Lugares rotación media/alta.

- Suitable for towel roll and Z-fold towels.
- Key lock.
- Versatile product: several options and different finishes.
- Double use: good service guaranteed.
- Places with medium to high traffic of people.

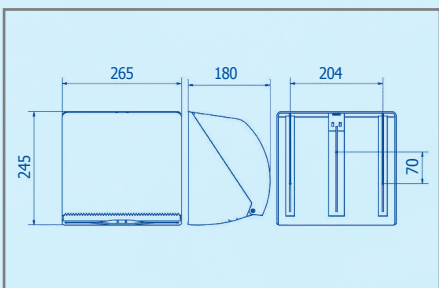

Dimensiones embalaje: (mm) 250
Packaging dimensions: 280 188



AH45000

- ABS Blanco
- White ABS



AH46000

- SAN Fumé
- Smoke SAN

Características Técnicas Technical Characteristics	AH45000	AH46000
Peso Neto/Bruto Net/Gross Weight (Kg)	0,950 / 1,160	0,950 / 1,160
Rollo Ø Máx. Max. Ø Roll (mm)	130	130
Rollo Ancho Máx. Max. Width Roll (mm)	240	240
Mandril Ø Bobina Jumbo Roll Ø Mandrel (mm)	25	25
Rollo Roll (m)	90	90
Toallas "Z" "Z" and "W" fold hand towels	400	400

- FIJACIÓN: 4 tornillos + 4 tacos (incluidos). | FIXING: 4 screws + 4 plugs (included).
- EMBALAJE: Unitario. | PACKAGING: Single.
- LIMPIEZA: Bayeta húmeda. No usar productos químicos. | CLEANING: Damp cloth. Don't use chemicals.

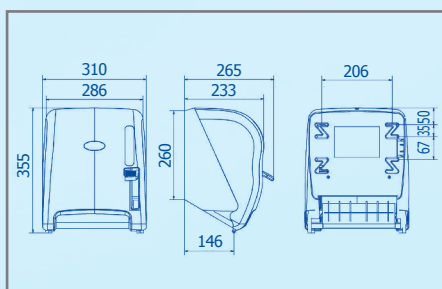

Dimensiones embalaje: (mm) 380
Packaging dimensions: 315 280

DISPENSADORES PALANCA "AZUR" "AZUR" LEVER ACTIVATED ROLL TOWEL DISPENSERS AG15500 - AG16500 - AG14800

- Dispensadores rollo papel continuo.
- Por accionamiento palanca.
- Cerradura con llave.
- Economía e higiene.
- Frontal abatible, con visor de carga.
- Cuchilla interior protegida.

- Towel roll dispensers.
- Operated by means of lever.
- Key lock.
- Savings and hygiene.
- Reclining cover, content viewer.
- Internal cutter protected.



AG15500

- SAN Fumé
- Smoke SAN



AG16500

- ABS Blanco
- White ABS



AG14800

- ABS Níquelado
- Nicked ABS

Características Técnicas Technical Characteristics	AG15500	AG16500	AG14800
Peso Neto/Bruto Net/Gross Weight (Kg)	2,300 / 2,960	2,300 / 2,960	2,300 / 2,960
Rollo Long. Máx. Max. Length Roll (m)	220	220	220
Rollo Ø Máx. Max. Ø Roll (mm)	190	190	190
Rollo Ancho Máx. Max. Width Roll (mm)	35 / 45	35 / 45	35 / 45

- FIJACIÓN: 4 tornillos + 4 tacos (incluidos). | FIXING: 4 screws + 4 plugs (included).
- EMBALAJE: Unitario. | PACKAGING: Single.
- LIMPIEZA: Bayeta húmeda. No usar productos químicos. | CLEANING: Damp cloth. Don't use chemicals.

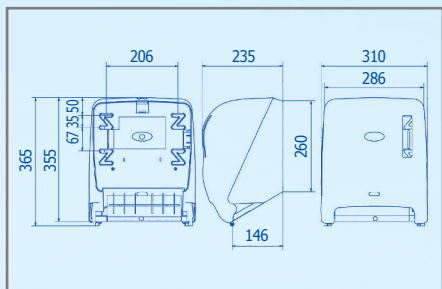

Dimensiones embalaje: (mm) 380
Packaging dimensions: 315 275

DISPENSADORES AUTOMÁTICO "AZUR" "AZUR" SENSOR ROLL TOWEL DISPENSERS AG17550 - AG18550 - AG19800

- Dispensadores rollo papel continuo.
- Por aproximación de manos.
- Alimentación por baterías o red.
- Economía e higiene: usa/toca.
- Cerradura con llave.
- Frontal abatible con visor de carga.

- Towel roll dispensers.
- Activates by approaching hands.
- Suitable for power or batteries.
- Savings and hygiene: use/touch.
- Key lock.
- Reclining cover with content viewer.



AG17550

- ABS Blanca
- White ABS



AG18550

- SAN Fumé
- Smoke SAN



AG19800

- ABS Níquelado
- Nicked ABS

- Baterías: 4 "D" LR20.
- Refs: AF17550/18550/19800 se activan si no hay papel expuesto.
- Servicios regulables: 240 o 360 mm.
- Adaptador mandril Ø 35/45 incluido.
- Batteries: 4 "D" LR20.
- Refs: AF17550/18550/19800 only operates when there is no paper showed.
- Adjustable services: 240 or 360 mm.
- Mandril adapter Ø 35/45 mm included.

Características Técnicas Technical Characteristics	AG17550	AG18550	AG19800
Peso Neto/Bruto Net/Gross Weight (Kg)	2,465 / 3,055	2,465 / 3,055	2,465 / 3,055
Rollo Ø Máx. Max. Ø Roll (mm)	220	220	220
Rollo Ancho Máx. Max. Width Roll (mm)	200	200	200
Mandril Ø Rollo Roll Ø Mandrel (mm)	35 / 45	35 / 45	35 / 45
Servicio Service (mm)	240 / 360	240 / 360	240 / 360

- FIJACIÓN: 4 tornillos + 4 tacos (incluidos). | FIXING: 4 screws + 4 plugs (included).
- EMBALAJE: Unitario. | PACKAGING: Single.
- LIMPIEZA: Bayeta húmeda. No usar productos químicos. | CLEANING: Damp cloth. Don't use chemicals.



DISPENSADORES PAPEL MECHA "CLÁSICA" (BOX) "CLASICA" CENTREFEED DISPENSERS

AG20020 - AG21050

- Dispensadores central rollo papel.
- Cerradura con llave.
- Rollo dispensado por centro/base.
- Higiene: usa/toca.
- Rollos hasta Ø 205 mm sin mandril ni precorte.
- Forma troncocónica.

- Centrefeed towel roll dispensers.
- Key lock.
- Special roll dispensed by centre/base.
- Hygiene: use/touch.
- Rolls up to 205 Ø, non mandrel, non-perforated.
- Tapered shape.

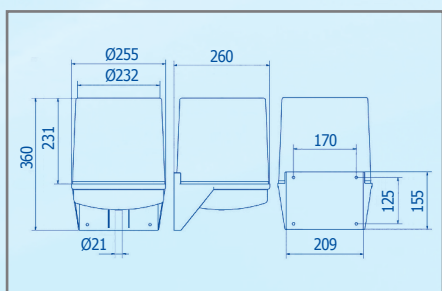

Dimensiones embalaje: (mm) 375
Packaging dimensions: 265 265



AG20020

- ABS Blanca
- White ABS



AG21050

- SAN Fumé
- Smoke SAN

Características Técnicas Technical Characteristics	AG20020	AG21050
Base y Soporte Pared Base and wall support	ABS Blanca White ABS	ABS Blanca White ABS
Carcasa Cover	ABS Blanca White ABS	SAN Fumé Smoke SAN
Peso Neto/Bruto Net/Gross Weight (Kg)	1,025 / 1,295	1,025 / 1,295
Rollo Ø Máx. Max. Ø Roll (mm)	205	205
Rollo Precorte Perforated Roll (mm)	X	X

- FIJACIÓN: 4 tornillos + 4 tacos (incluidos). | FIXING: 4 screws + 4 plugs (included).
- EMBALAJE: Unitario. | PACKAGING: Single.
- LIMPIEZA: Bayeta húmeda. No usar productos químicos. | CLEANING: Damp cloth. Don't use chemicals.



DISPENSADORES PAPEL MECHA MINI "AZUR" (MINI-BOX) "AZUR" MINI CENTREFEED DISPENSERS

AG32000 - AG33200 - AG33400

- Dispensadores central rollo papel.
- Cerradura con llave con frontal abatible.
- Rollo dispensado por el centro/base.
- Rollos hasta Ø 130 mm sin mandril ni precorte.

- Centrefeed towel roll dispensers.
- Key lock, reclining front cover.
- Special roll, delivered by centre / base.
- For rolls up to Ø 130 mm, without mandrel, non-perforated.

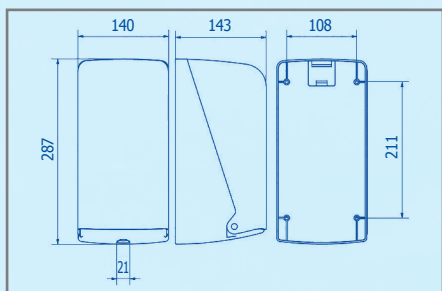

Dimensiones embalaje: (mm) 295
Packaging dimensions: 145 145



AG32000



AG33200



AG33400

Características Técnicas Technical Characteristics	AG32000	AG33200	AG33400
Carcasa Cover	ABS Blanca / White ABS	SAN Azul / Blue SAN	SAN Fumé / Smoke SAN
Base y Soporte Pared Base and Wall Support	ABS Blanca / White ABS	ABS Blanca / White ABS	ABS Blanca / White ABS
Peso Neto/Bruto Net/Gross Weight (Kg)	0,615 / 0,710	0,615 / 0,710	0,615 / 0,710
Rollo Ø Máx. Max. Ø Roll (mm)	130	130	130
Rollo Ancho Máx. Max. Width Roll (mm)	210	210	210
Rollo Precorte Perforated Roll (mm)	X	X	X

- FIJACIÓN: 4 tornillos + 4 tacos (incluidos). | FIXING: 4 screws + 4 plugs (included).
- EMBALAJE: Unitario. | PACKAGING: Single.
- LIMPIEZA: Bayeta húmeda. No usar productos químicos. | CLEANING: Damp cloth. Don't use chemicals.

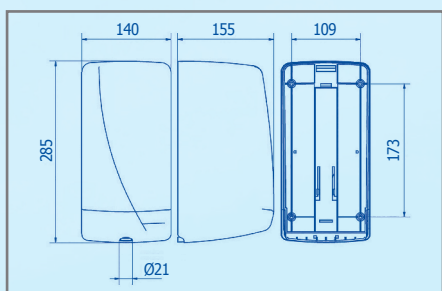

Dimensiones embalaje: (mm) 295
Packaging dimensions: 145 155

DISPENSADORES PAPEL MECHA MINI "FUTURA" (MINI-BOX) "FUTURA" MINI CENTREFEED DISPENSERS

AG35000 - AG35500

- Dispensadores central rollo papel.
- Cerradura con llave con frontal abatible.
- Rollo especial dispensado por el centro/base.
- Rollos hasta Ø 130 mm sin mandril ni precorte.
- Centrefeed towel roll dispensers.
- Key lock, reclining front cover.
- Special roll, delivered by centre/base.
- For rolls up to Ø 130 mm, without mandrel, non-perforated.



AG35000

- Acero Inox Satinado
- Satin Stainless Steel



AG35500

- Acero Inox Brillo
- Bright Stainless Steel

Características Técnicas Technical Characteristics	AG35000	AG35500
Peso Neto/Bruto Net/Gross Weight (Kg)	1,160 / 1,310	1,160 / 1,310
Rollo Ø Máx. Max. Ø Roll (mm)	130	130
Rollo Ancho Máx. Max. Width Roll (mm)	210	210
Rollo Precorte Perforated Roll	X	X

- FIJACIÓN: 4 tornillos + 4 tacos (incluidos). | FIXING: 4 screws + 4 plugs (included).
- EMBALAJE: Unitario. | PACKAGING: Single.
- LIMPIEZA: Bayeta húmeda. No usar productos químicos. | CLEANING: Damp cloth. Don't use chemicals.

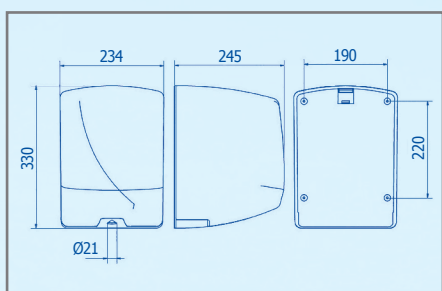

Dimensiones embalaje: (mm) 330
Packaging dimensions: 250 240

DISPENSADORES PAPEL MECHA "FUTURA" (BOX) "FUTURA" CENTREFEED DISPENSERS

AG45000 - AG45500

- Dispensadores central rollo papel.
- Cerradura con llave con frontal abatible.
- Rollo dispensado por el centro/base.
- Higiene: usa/toca.
- Rollos hasta Ø 205 mm.
- Varias opciones acabado.
- Centrefeed towel roll dispensers.
- Key lock, reclining front cover.
- Special roll, dispensed by centre/base.
- Hygiene: use/touch.
- For rolls up to Ø 205 mm.
- Multiple finish options.



AG45000

- Acero Inox Satinado
- Satin Stainless Steel



AG45500

- Acero Inox Brillo
- Bright Stainless Steel

Características Técnicas Technical Characteristics	AG45000	AG45500
Peso Neto/Bruto Net/Gross Weight (Kg)	2,475 / 2,745	2,475 / 2,745
Rollo Ø Máx. Max. Ø Roll (mm)	205	205
Rollo Precorte Perforated Roll	X	X

- FIJACIÓN: 4 tornillos + 4 tacos (incluidos). | FIXING: 4 screws + 4 plugs (included).
- EMBALAJE: Unitario. | PACKAGING: Single.
- LIMPIEZA: Bayeta húmeda. No usar productos químicos. | CLEANING: Damp cloth. Don't use chemicals.



DISPENSADORES PAPEL MECHA "AZUR" (BOX) "AZUR" CENTREFEED DISPENSERS

AG40000 - AG40700 - AG41200 - AG41400 - AG42000 - AG43000

- Dispensadores central rollo papel.
- Cerradura con llave con frontal abatible.
- Rollo especial dispensado por el centro/base.
- Higiene: usa/toca.
- Rollos hasta Ø 205 mm sin mandril.
- Múltiples opciones: Blanco, Azul, Fumé, Antibacteriano, Precorte.
- Centrefeed towel roll dispensers.
- Key lock, reclining front cover.
- Special roll dispensed by centre/base.
- Hygiene: use/touch.
- For rolls up to Ø 205 mm, without mandrel.
- Multiple options: White, Blue, Smoke, Antibacterial, Perforated.

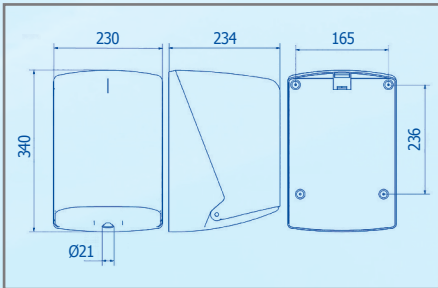

Dimensiones embalaje: (mm) 355
Packaging dimensions: 240 245



AG40000

- ABS Blanco
- White ABS



AG40700

- ABS Antibac Blanco
- White Antibac ABS



AG41200

- SAN Azul
- Blue SAN



AG41400

- SAN Fumé
- Smoke SAN



AG42000

- ABS Blanco
- White ABS



AG43000

- SAN Fumé
- Smoke SAN

Características Técnicas Technical Characteristics		AG40000	AG40700	AG41200	AG41400	AG42000	AG43000
Peso Neto Net Weight	(Kg)	1,235	1,235	1,235	1,235	1,360	1,360
Peso Bruto Gross Weight	(Kg)	1,490	1,490	1,490	1,490	1,555	1,555
Rollo Ø Máx. Max. Ø Roll	(mm)	205	205	205	205	205	205
Bobina precortada Perforated Roll		X	X	X	X	X	X
Mecanismo corte Cutting Mechanism		—	—	—	—	X	X
Antibacteriano Antibacterial		—	X	—	—	—	—

• FIJACIÓN: 4 tornillos + 4 tacos (incluidos). | FIXING: 4 screws + 4 plugs (included).
• EMBALAJE: Unitario. | PACKAGING: Single.

• LIMPIEZA: Bayeta húmeda. No usar productos químicos.
CLEANING: Damp cloth. Don't use chemicals.



DISPENSADORES PAPEL MECHA "SMART" (BOX) "SMART" CENTREFEED DISPENSERS

AG47000 - AG47600

- Dispensadores central rollo papel.
- Cerradura con llave.
- Frontal abatible con visor de carga.
- Rollo dispensado por el centro/base.
- Rollos hasta Ø 200 mm sin mandril ni precorte.
- Línea económica "Low Cost".
- Centrefeed towel roll dispensers.
- Key lock.
- Reclining front cover with content viewer.
- Roll delivered by base/centre.
- For rolls up to Ø 200 mm, without mandrel, non-perforated.
- "Low Cost" range of products.

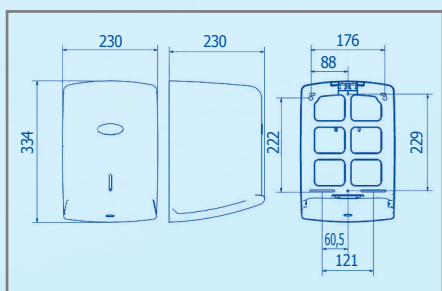

Dimensiones embalaje: (mm) 335
Packaging dimensions: 240 245



AG47000

- ABS Blanco
- White ABS



AG47600

- ABS Negro
- Black ABS

Características Técnicas Technical Characteristics	AG47000	AG47600
Peso Neto/Bruto Net/Gross Weight (Kg)	0,755 / 0,950	0,755 / 0,950
Rollo Ø Máx. Max. Ø Roll (mm)	205	205
Rollo Ancho Máx. Max. Width Roll (mm)	230	230
Rollo sin Precorte Non Perforated Roll	X	X

- FIJACIÓN: 3 tornillos + 3 tacos (incluidos). | FIXING: 3 screws + 3 wall plugs (included).
- EMBALAJE: Unitario. | PACKAGING: Single.
- LIMPIEZA: Bayeta húmeda. No usar productos químicos. | CLEANING: Damp cloth. Don't use chemicals.

CAMBIADORES PAÑALES > NAPPY CHANGINGS TABLES

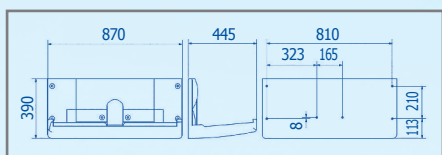

Dimensiones embalaje: (mm) 455
Packaging dimensions: 900 110

CAMBIADORES PAÑALES NAPPY CHANGINGS UNIT

AY10000 - AY11000

- Plataforma abatible de Polietileno Alta Densidad (HDPE).
- Base cóncava.
- Antibacteriano.
- Inyectado en una sola pieza.
- Sujeción a pared mediante brazo articulado oculto de acero.
- Amortiguador neumático.
- Incorpora cinturón de seguridad.
- Tornillos y anclajes ocultos.
- Bolsillos para pañales y toallas.
- Código Braille (invidentes)
- Uso Universal.
- Reclining platform made of High Density Polyethylene (HDPE).
- Concave shape.
- Antibacterial.
- Unibody chasis.
- Fixed to wall by means of a hidden articulated arm, made of steel.
- Pneumatic shock absorbing system.
- Includes adjustable safety straps.
- Screws and wall plugs concealed.
- Pockets for nappies and wipes.
- Braille Code (blinds)
- Widespread use.

- HOMOLOGACIONES: ASTM; G21; G22. ADA (USA). AINSI (CE).
- CERTIFICACIONES: ASTM; G21; G22. ADA (USA). AINSI (CE).
- FIJACIÓN: 4 puntos con tornillería (incluida). FIXING: 4 points with screws (included).
- EMBALAJE: Unitario. | PACKAGING: Single.
- LIMPIEZA: Bayeta húmeda. No usar productos químicos. CLEANING: Damp cloth. Don't use chemicals.



AY10000

- Polietileno (HDPE) Gris
- Polyethylene (HDPE) Grey



AY11000

- Polietileno (HDPE) Gris
- Polyethylene (HDPE) Grey

Características Técnicas Technical Characteristics	AY10000	AY11000
Peso Neto/Bruto Net/Gross Weight (Kg)	6,380 / 7,455	7,945 / 9,135
Peso Soportado Weight Bearing (Kg)	130	130

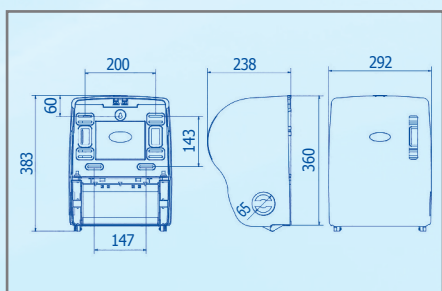

Dimensiones embalaje: (mm) 395
Packaging dimensions: 300 250

DISPENSADORES AUTOCORTANTES "AZUR" "AZUR" AUTOCUT DISPENSERS

AG56000 - AG56600 - AG57000 - AG58000 - AG59000 - AG59500

- Dispensan servicios precortados de 27 cm.
- Requieren papel especial autocortante.
- Acción manual sobre el papel, exclusivamente.
- Máxima higiene: usa/toca.
- Evitan contaminación cruzada.
- Cuchilla interior de acero templado.
- Rueda de seguridad lateral.
- Cerradura con llave.
- Frontal abatible con visor de carga.
- Diámetro máximo bobina 210 mm.
- Bobina ancho máximo 210 y mínimo 191 mm.
- Economía de uso y consumo de papel.
- Mandril Ø mínimo 36 y máximo 45 mm.
- Recarga fácil y rápida.
- Última tecnología de Dispensadores.
- Para lugares con alta rotación.
- Varias opciones de acabado: Blanco, Fumé, Negro, Níquel, Inox.
- Dispenses precut towels, 27 cm long.
- Requires special perforated paper.
- Manual operation of paper, exclusively.
- Maximum hygiene: use/touch.
- Prevents cross-contamination.
- Internal cutter made of mild steel.
- Security side wheel.
- Key lock.
- Reclining front cover, content viewer.
- Maximum diameter of roll: 210 mm.
- Roll: 210 mm maximum - 191 mm minimum.
- Reduced cost, paper saving.
- Mandrel: 36 Ø minimum, 45 mm maximum.
- Easy and quick to refill.
- Latest technology in paper dispensers.
- For places with high traffic of people.
- Several finish options available: White, Smoked, Black, Nickel, Stainless Steel.



AG56000

- ABS Blanco
- White ABS



AG56600

- ABS Negro
- Black ABS



AG57000

- ABS Fumé
- Smoke ABS



AG58000

- ABS Niquelado
- Nickered ABS



AG59000

- Acero Inox Satinado
- Satin Stainless Steel



AG59500

- Acero Inox Brillo
- Bright Stainless Steel

FEBRERO 2018
FEBRUARY 2018

Características Técnicas Technical Characteristics	AG56000	AG56600	AG57000	AG58000	AG59000	AG59500
Peso Neto Net Weight (Kg)	2,030	2,030	2,030	2,030	3,295	3,295
Peso Bruto Gross Weight (Kg)	2,505	2,505	2,505	2,505	3,770	3,770
Bobina Ø Máx. Max. Ø Jumbo Roll (mm)	210	210	210	210	210	210
Bobina Ancho Máx. Jumbo Roll Max. Width (mm)	210	210	210	210	210	210
Bobina Ancho Min. Jumbo Roll Min. Width (mm)	191	191	191	191	191	191
Mandril Ø Máx./Min Mandrel: Ø Max./Min (mm)	45 / 36	45 / 36	45 / 36	45 / 36	45 / 36	45 / 36
Servicios Services (mm)	270	270	270	270	270	270

• FIJACIÓN: 4 tornillos + 4 tacos (incluidos). | FIXING: 4 screws + 4 plugs (included).
• EMBALAJE: Unitario. | PACKAGING: Single.

• LIMPIEZA: Bayeta húmeda. No usar productos químicos. | CLEANING: Damp cloth. Don't use chemicals.

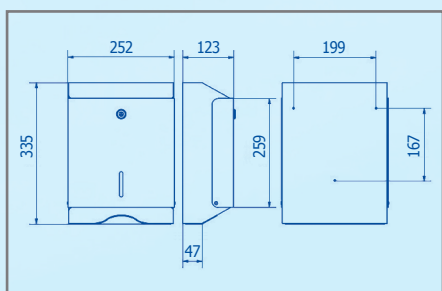

Dimensiones embalaje: (mm) 358
Packaging dimensions: 260 127

DISPENSADORES TOALLAS ZIG-ZAG "CLÁSICA" "CLASICA" "Z" FOLD TOWEL DISPENSERS

AH12000 - AH14000 - AH20000

- Dispensadores toallas Z y W.
- Antivandálicos.
- Cerradura con llave.
- Frontal abatible con visor de carga.
- Lugares de alta rotación.
- Z and W-fold towels dispensers.
- Antivandalism.
- Key lock.
- Reclining front cover, content viewer.
- For places with high traffic of people.



AH12000



AH14000



AH20000

Características Técnicas Technical Characteristics	AH12000	AH14000	AH20000
Carcasa Cover	Inox / S.Steel	Inox / S.Steel	Acero / S.Steel
Acabado Finish	Brillo / Bright	Satinado / Satin	Blanco / White
Pintura Polyester Polyester Paint	—	—	X
Peso Neto/Bruto Net/Gross Weight (Kg)	1,585 / 1,750	1,920 / 2,075	1,905 / 2,065
Espesor Thickness (mm)	0,8	0,8	0,8
Toallas "Z" y "W" "Z" and "W" fold hand towels	600 / 400	600 / 400	600 / 400

- FIJACIÓN: 4 tornillos + 4 tacos (incluidos). | FIXING: 4 screws + 4 plugs (included).
- EMBALAJE: Unitario. | PACKAGING: Single.
- LIMPIEZA: Bayeta húmeda. No usar productos químicos. | CLEANING: Damp cloth. Don't use chemicals.

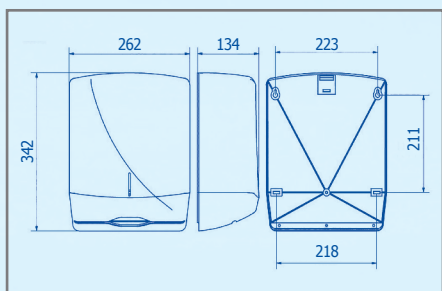

Dimensiones embalaje: (mm) 355
Packaging dimensions: 277 145

DISPENSADORES TOALLAS ZIG-ZAG "FUTURA" "FUTURA" "Z" FOLD TOWEL DISPENSERS

AH25000 - AH25500

- Dispensadores toallas Z y W.
- Antivandálicos.
- Cerradura con llave.
- Frontal abatible con visor de carga.
- Higiénico: sin contaminación cruzada.
- Lugares de alta rotación.
- Z and W-fold towels dispensers.
- Antivandalism.
- Key lock.
- Reclining front cover, content viewer.
- Hygienic: prevents cross contamination.
- For places with high traffic of people.



AH25000

- Acero Inox Satinado
- Satin Stainless Steel



AH25500

- Acero Inox Brillo
- Bright Stainless Steel

Características Técnicas Technical Characteristics	AH25000	AH25500
Peso Neto/Bruto Net/Gross Weight (Kg)	1,710 / 1,930	1,710 / 1,930
Espesor Thickness (mm)	0,8	0,8
Toallas "Z" y "W" "Z" and "W" fold hand towels	600 / 400	600 / 400

- FIJACIÓN: 4 tornillos + 4 tacos (incluidos). | FIXING: 4 screws + 4 plugs (included).
- EMBALAJE: Unitario. | PACKAGING: Single.
- LIMPIEZA: Bayeta húmeda. No usar productos químicos. | CLEANING: Damp cloth. Don't use chemicals.

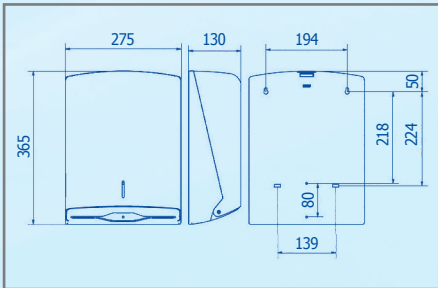

Dimensiones embalaje: (mm) 370
Packaging dimensions: 275 130

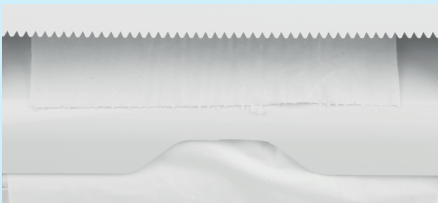

DISPENSADORES TOALLAS ZIG-ZAG "AZUR" "AZUR" "Z" FOLD TOWEL DISPENSERS

AH33000 - AH33700 - AH34200 - AH34400

- Dispensadores toallas Z.
- Cerradura con llave.
- Frontal abatible con visor de carga.
- Higiénico: evitan contaminación cruzada.
- Lugares de alta rotación.
- Z-fold towel dispensers.
- Key lock.
- Reclining front cover, content viewer.
- Hygienic: presents cross contamination.
- For places with high traffic.



AH33000

AH33700

AH34200

AH34400

AH38000

Características Técnicas Technical Characteristics	AH33000	AH33700	AH34200	AH34400	AH38000
Carcasa Cover	ABS	ABS Antibac Antibac ABS	SAN	SAN	ABS
Acabado Finish	Blanco / White	Blanco / White	Azul / Blue	Fumé / Smoke	Niquelado Nickelated
Peso Neto/Bruto Net/Gross Weight	(Kg) 0,885 / 1,025	0,885 / 1,025	0,885 / 1,025	0,885 / 1,025	0,680 / 0,810
Antibacteriano Antibacterial	-	X	-	-	-
Toallas "Z" y "W" "Z" and "W" fold hand towels	600 / 400	600 / 400	600 / 400	600 / 400	600 / 400

- FIJACIÓN: 4 tornillos + 4 tacos (incluidos). | FIXING: 4 screws + 4 plugs (included).
- EMBALAJE: Unitario. | PACKAGING: Single.
- LIMPIEZA: Bayeta húmeda. No usar productos químicos. | CLEANING: Damp cloth. Don't use chemicals.

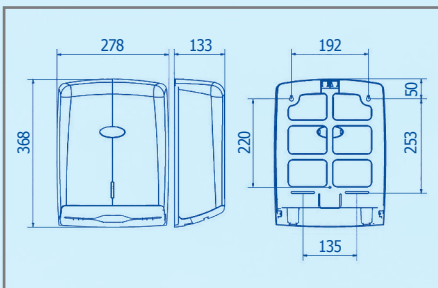

Dimensiones embalaje: (mm) 370
Packaging dimensions: 275 130

DISPENSADORES TOALLAS ZIG-ZAG "SMART" "SMART" "Z" FOLD TOWEL DISPENSERS

AH37000 - AH37600 - AH38000

- Dispensadores toallas Z.
- Cerradura con llave.
- Frontal abatible.
- Higiénico: evitan contaminación cruzada.
- Visor de carga.
- Lugares de alta rotación.
- Z-fold towel dispensers.
- Key lock.
- Reclining cover.
- Hygienic: prevents cross contamination.
- Content viewer
- For places with high traffic of people.



AH37000

- ABS Blanco
- White ABS



AH37600

- ABS Negro
- Black ABS

Características Técnicas Technical Characteristics	AH37000	AH37600
Carcasa Cover	ABS	ABS
Acabado Finish	Blanco / White	Negro / Black
Peso Neto/Bruto Net/Gross Weight	(Kg) 0,680 / 0,810	0,680 / 0,810
Toallas "Z" y "W" "Z" and "W" fold hand towels	600 / 400	600 / 400

- FIJACIÓN: 4 tornillos + 4 tacos (incluidos). | FIXING: 4 screws + 4 plugs (included).
- EMBALAJE: Unitario. | PACKAGING: Single.
- LIMPIEZA: Bayeta húmeda. No usar productos químicos. | CLEANING: Damp cloth. Don't use chemicals.

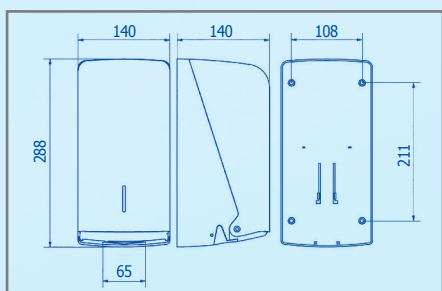

Dimensiones embalaje: (mm) 293
Packaging dimensions: 145 145

DISPENSADORES TOALLAS HIGIÉNICAS ZIG-ZAG “AZUR” “AZUR” Z-FOLD HAND TOWELS DISPENSERS AH70000 - AH71200 - AH71400

- Dispensan toallas Z.
- Cerradura con llave.
- Frontal abatible.
- Higiénico: evitan contaminación cruzada.
- Lugares rotación media/alta.
- Dispenses Z-fold hand towels.
- Key lock.
- Reclining cover.
- Hygienic: prevents cross contamination.
- For places with medium/high traffic.



AH70000



AH71200



AH71400

Características Técnicas Technical Characteristics	AH70000	AH71200	AH71400
Carcasa/Acabado Cover/Finish	ABS-Blanco / White-ABS	SAN-Azul / Blue-SAN	SAN-Fumé / Smoke-SAN
Soporte/Acabado Support/Finish	ABS-Blanco / White-ABS	ABS-Blanco / White-ABS	ABS-Blanco / White-ABS
Peso Neto/Bruto Net/Gross Weight (Kg)	0,540 / 0,625	0,540 / 0,625	0,540 / 0,625
Toallas “Z” “Z” fold bowels	400	400	400

- FIJACIÓN: 4 tornillos + 4 tacos (incluidos). | FIXING: 4 screws + 4 plugs (included).
- EMBALAJE: Unitario. | PACKAGING: Single.
- LIMPIEZA: Bayeta húmeda. No usar productos químicos. | CLEANING: Damp cloth. Don't use chemicals.

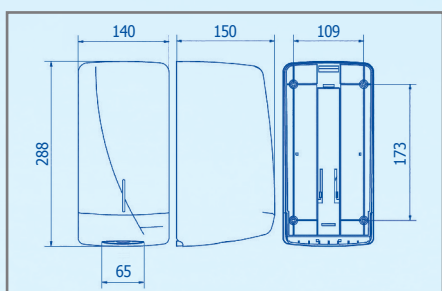

Dimensiones embalaje: (mm) 293
Packaging dimensions: 145 157

DISPENSADORES TOALLAS HIGIÉNICAS ZIG-ZAG “FUTURA” “FUTURA” Z-FOLD HAND TOWELS DISPENSERS AH75000 - AH75500

- Dispensan toallas Z.
- Cerradura con llave.
- Frontal abatible.
- Visor de carga
- Higiénico: evita contaminación cruzada.
- Lugares rotación media/alta.
- Dispenses Z-fold hand towels.
- Key lock.
- Reclining cover.
- Content viewer.
- Hygienic: prevents cross contamination.
- For places with medium to high traffic.



AH75000

- Acero Inox Satinado
- Satin Stainless Steel



AH75500

- Acero Inox Brillo
- Bright Stainless Steel

Características Técnicas Technical Characteristics	AH75000	AH75500
Peso Neto/Bruto Net/Gross Weight (Kg)	1,120 / 1,285	1,120 / 1,285
Espesor Thickness (mm)	0,8	0,8
Toallas “Z” “Z” fold bowels	400	400

- FIJACIÓN: 4 tornillos + 4 tacos (incluidos). | FIXING: 4 screws + 4 plugs (included).
- EMBALAJE: Unitario. | PACKAGING: Single.
- LIMPIEZA: Bayeta húmeda. No usar productos químicos. | CLEANING: Damp cloth. Don't use chemicals.

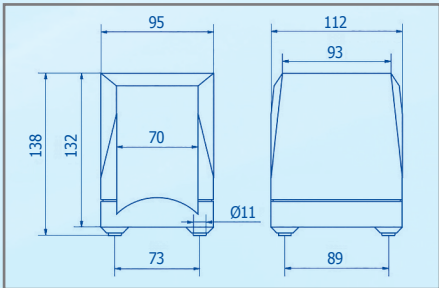

Dimensiones embalaje: (mm) 320
Packaging dimensions: 360 520

DISPENSADOR SERVILLETAS "AZUR" "AZUR" NAPKIN DISPENSER

AH50000

"CLASSIC"

- Dispensador servilletas mini-servicio.
- ABS bicolor.
- Carga y dispensa servilletas por ambos lados.
- Resorte interior para ajuste servilletas.
- Tacos goma en base antideslizante.
- Uso y venta masiva: colores s/ cantidad.

- Napkin dispenser, mini-service
- Bicolour ABS
- Double sided load, napkins also dispensed by both sides
- Internal spring to adjust napkins
- Anti-slip rubber pads on base
- Massive use and sale: colours depending on quantity ordered.

Características Técnicas | Technical Characteristics

		AH50000
Carcasa Cover		ABS
Acabado Finish		Gris / Grey
Base Base		ABS
Acabado Finish		Negro / Black
Peso Neto/Bruto	(Kg)	0,135
Net/Gross Weight	(Kg)	8,110 (30 u.)
Nº Servilletas Napkins		100

- EMBALAJE: 30 u. | PACKAGING: 30 u.
- LIMPIEZA: Bayeta húmeda. No usar productos químicos. | CLEANING: Damp cloth. Don't use chemicals.

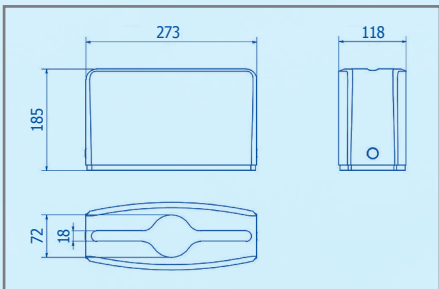

Dimensiones embalaje: (mm) 193
Packaging dimensions: 280 126

DISPENSADORES SERVILLETAS "AZUR" "AZUR" NAPKIN DISPENSERS

AH52000 - AH52600 - AH52800

"LUXE"

- Dispensadores de servilletas "Z" y "W".
- Desmontables por presión lateral.
- Tacos goma antideslizante.
- Resorte inferior para ajuste servilletas.
- Uso y venta masiva. Colores s/cantidad.

- Z and W fold napkin dispensers.
- Disassemble pushing on both sides.
- Anti-slip rubber pads.
- Internal spring to adjust napkins.
- Massive use and sale. Colours depending on quantity ordered.



AH52000



AH52600



AH52800

Características Técnicas | Technical Characteristics

	AH52000	AH52600	AH52800
Carcasa/Acabado Cover/Finish	ABS Blanco/White	ABS Negro/Black	ABS Niquelado/Nickelated
Base/Acabado Base/Finish	ABS Negro/Black	ABS Negro/Black	ABS Negro/Black
Peso Neto/Bruto Net/Gross Weight	(Kg) 0,500 / 0,705	0,500 / 0,705	0,500 / 0,705
Máx. "Z" Max. "Z"	(mm) 24x24	24x24	24x24
Máx. "W" Máx. "W"	(mm) 32x24	32x24	32x24
Nº Servilletas Napkins	250	250	250

- EMBALAJE: Unitario. | PACKAGING: Single.
- LIMPIEZA: Bayeta húmeda. No usar productos químicos. | CLEANING: Damp cloth. Don't use chemicals.

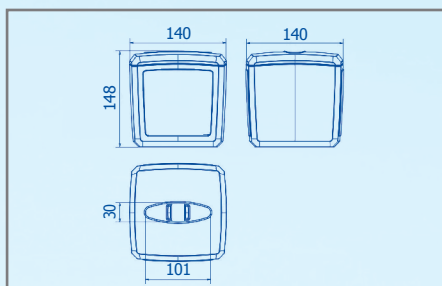
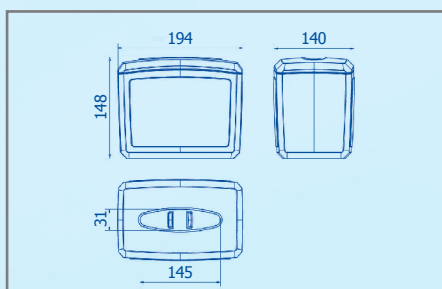

SERVILLETOS RECTANGULAR "STANDARD" SERVILLETERO CUADRADO "STANDARD" "STANDARD" RECTANGULAR NAPKIN DISPENSERS "STANDARD" SQUARED NAPKIN DISPENSERS AH53000Z - AH54000Z

- Tapa, carcasa y base en ABS color.
- Tapa abatible con bisagras laterales y cierre "Clip".
- Base interior con resorte para ajuste progresivo de las servilletas
- Dos laterales publicitarios en SAN transparente.
- Cuatro tacos de goma antideslizantes.
- Capacidad para 200 servilletas "Z" de 16x20 / 10x20 cm.
- Dispensa servilletas por abertura longitudinal central en la tapa.
- Color claro para disimular el efecto pelusa papel.
- Posibilidad elección color para grandes cantidades.
- Cover, case and base made ABS.
- Swivel cover with hinges "Clip" closing system.
- Equipped with spring to adjust napkins gradually.
- Two sides for advertising, made of transparent SAN.
- Four non-slip rubber pads.
- Capacity: 200 "Z"-Fold napkins, 16x20 / 10x20 cm.
- Napkins dispensed by central longitudinal opening at cover.
- Light colour to disguise paper fluff.
- Free choice of colour for large orders.



AH53000Z

- ABS Azul
- Blue ABS

**FEBRERO 2018
FEBRUARY 2018**



AH54000Z

- ABS Azul
- Blue ABS

**FEBRERO 2018
FEBRUARY 2018**

Características Técnicas Technical Characteristics	AH53000Z	AH54000Z
Carcasa Cover	ABS	ABS
Acabado Finish	Azul / Blue	Azul / Blue
Peso Neto/Bruto Net/Gross Weight (Kg)	0,435 / 5,845 (12u)	0,355 / 9,580 (24u)
Nº Servilletas Napkins	200	200
Servilletas Napkins	16 x 20	10 x 20



- EMBALAJE: AH53000Z = 12 u.; AH54000Z = 24 u. | PACKAGING: AH53000Z = 12 u.; AH54000Z = 24 u.
- LIMPIEZA: Bayeta húmeda. No usar productos químicos. | CLEANING: Damp cloth. Don't use chemicals.

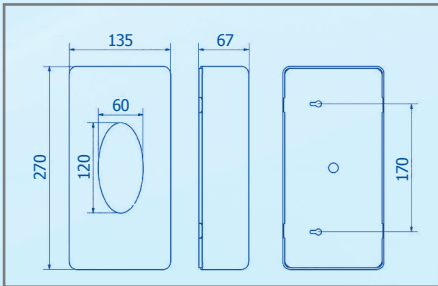

Dimensiones embalaje: (mm) 165
Packaging dimensions: 290 440
290



DISPENSADORES FACIALES "AZUR/FUTURA" "AZUR/FUTURA" FACIAL TISSUES DISPENSERS

AH60000 - AH61200 - AH61400 - AH65000 (AZUR) / AH66000 - AH66500 (FUTURA)

- Dispensadores sobremesa o pared de toallas faciales.
- Carcasa superior desmontable.
- Dispensan por parte superior.
- Diseñados para alojar estuche standard.
- Lujosos y decorativos.
- En Acero Inox., brillo o satinado (FUTURA).
- En ABS Blanco o Cromado, SAN Azul o Fumé.
- Posibilidad particularización.
- Wall/table top facial tissues dispensers.
- Detachable casing.
- Tissues delivered by upper opening.
- Designed for standard packages.
- Luxurious and ornamental.
- (FUTURA) Stainless Steel, bright of satin finish.
- (AZUR) White ABS or Chromed, Blue or Smoked SAN.
- Can be customized.

AZUR



AH60000

- ABS Blanco
- White ABS



AH61200

- SAN Azul
- Blue SAN



AH61400

- SAN Fumé
- Smoke SAN



AH65000

- Cromado
- Chromed

FUTURA



AH66000

- Acero Inox Satinado
- Satin Stainless Steel



AH66500

- Acero Inox Brillo
- Bright Stainless Steel

Características Técnicas Technical Characteristics	AH60000	AH61200	AH61400	AH65000	AH66000	AH66500
Carcasa Cover	ABS	SAN	SAN	SAN	Inox / S.Steel	Inox / S.Steel
Acabado Finish	Blanco / White	Azul / Blue	Fumé / Smoke	Cromado Chromed	Satinado / Satin	Brillo / Bright
Base Base	ABS	ABS	ABS	ABS	ABS	ABS
Acabado Finish	Blanco / White	Blanco / White	Blanco / White	Gris / Grey	Gris / Grey	Gris / Grey
Peso Neto Net Weight	(Kg) 0,295	0,295	0,295	0,295	0,460	0,460
Peso Bruto Gross Weight	(Kg) 2,125 (6 u.)	2,125 (6 u.)	2,125 (6 u.)	2,125 (6 u.)	0,550	0,550
Nº Faciales Facial Towels	100	100	100	100	100	100

- FIJACIÓN: Sobremesa o pared 2 tornillos + 2 tacos (incluidos).
FIXING: Tabel our wall 2 screws + 2 wall plugs (included).
- EMBALAJE: Unitario. | PACKAGING: Single.

- LIMPIEZA: Bayeta húmeda. No usar productos químicos.
CLEANING: Damp cloth. Don't use chemicals.



EXTERMINADOR ELÉCTRICO INSECTOS LAMP INSECT KILLERS

AJ12000

- Farolillo cilíndrico en ABS blanco.
- Rejilla plástica protectora.
- Luz ultravioleta y bandeja inferior.
- Rejilla interior cargada eléctricamente.
- Acción doble: luz atrae, rejilla elimina.
- Cable alimentación con enchufe.
- Cylindrical lamp made of White ABS.
- Plastic protection grid.
- Ultraviolet light, capture tray.
- Internal grid electrically charged.
- Double action: light to attract, grid to kill.
- Power cable with plug.

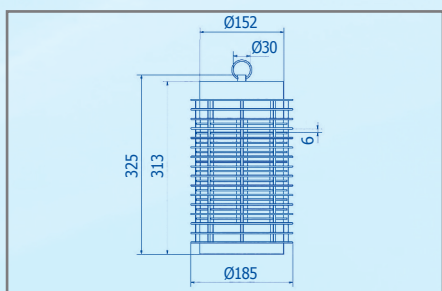

Dimensiones embalaje: (mm) 345
Packaging dimensions: 200 205

Características Técnicas Technical Characteristics		AJ12000
Carcasa Cover		ABS
Color Colour		Blanco / White
Peso Neto/Bruto Net/Gross Weight	(Kg)	1,460 / 1,635
Tensión Tension	(V)	220-230
Frecuencia Frequency	(Hz)	50-60
Tubos Tubes	(n/W)	1/11
Potencia Power	(W)	13
Rejilla Grid	(V)	2.000
Rejilla Grid	(A)	0,005
Área Area	(m ²)	125

- FIJACIÓN: Techo o Sobremesa. | FIXING: Ceiling or table.
- EMBALAJE: Unitario. | PACKAGING: Single.
- LIMPIEZA: Bayeta húmeda. No usar productos químicos. | CLEANING: Damp cloth. Don't use chemicals.



EXTERMINADORES ELÉCTRICOS INSECTOS (DT-6; DT-15) ELECTRIC INSECT KILLERS (DT-6; DT-15)

AJ21500C - AJ54000C

- Parrillas de seguridad en Aluminio Anodizado.
- Luz ultravioleta y bandeja inferior.
- Rejilla interior cargada eléctricamente.
- Acción doble: luz atrae, rejilla elimina.
- Cable alimentación con enchufe.
- Security grill made of Anodised Aluminium.
- Ultraviolet light, capture tray.
- Internal grid electrically charged.
- Double action: light to attract, grid to kill.
- Power cable with plug.

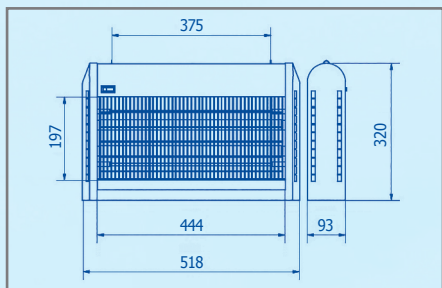

Dimensiones embalaje: (mm) 455
Packaging dimensions: 565 140



AJ21500C

- Aluminio Laterales Gris: PC
- Aluminium Grey Sides: PC



AJ54000C

- Aluminio Laterales Gris: PC
- Aluminium Grey Sides: PC

Características Técnicas Technical Characteristics		AJ21500C	AJ54000C
Peso Neto/Bruto Net/Gross Weight	(Kg)	2,100 / 2,485	3,140 / 3,800
Tensión/Frecuencia Tension/Frequency	(V/Hz)	220/230 50/60	220/230 50/60
Tubos Tubes	(n/W)	2 / 6	2 / 15
Potencia Power	(W)	12	30
Rejilla Grid	(V/A)	2.500 / 0,007	2.500 / 0,007
Área Area	(m ²)	200	400

- FIJACIÓN: Techo o Sobremesa (incluye cadena). | FIXING: Ceiling or table (chain included).
- EMBALAJE: Unitario. | PACKAGING: Single.
- LIMPIEZA: Bayeta húmeda. No usar productos químicos. | CLEANING: Damp cloth. Don't use chemicals.

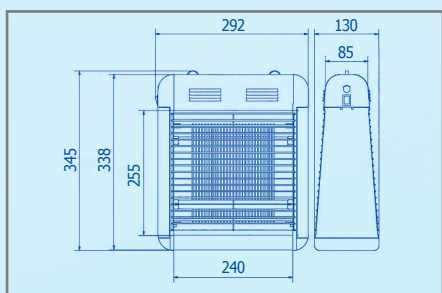

Dimensiones embalaje: (mm) 390
Packaging dimensions: 358 165

EXTERMINADOR ELÉCTRICO INSECTOS (DT-8; T-11; DT11; T-15; DT15; DT20; TT-15; TT-20) ELECTRIC INSECT KILLERS

(DT-8; T-11; DT11; T-15; DT15; DT20; TT-15; TT-20)

AJ21510-AJ22010-AJ22510-AJ23510-AJ54010-AJ55010-AJ56010-AJ57010

- Parrillas de seguridad de Acero Inox.
- Laterales en Policarbonato.
- Luz ultravioleta y bandeja inferior.
- Rejilla interior cargada eléctricamente.
- Acción doble: luz atrae, rejilla elimina.
- Cable alimentación con enchufe.

- Security grid made of Stainless Steel.
- Sides of Polycarbonate.
- Ultraviolet light, capture tray.
- Internal grid electrically charged.
- Double action: light to attract, grid to kill.
- Power cable with plug.



AJ21510

- Inox
- Laterales: PC
- Stainless Steel
- Sides: PC



AJ22010

- Inox
- Laterales: PC
- Stainless Steel
- Sides: PC



AJ22510

- Inox
- Laterales: PC
- Stainless Steel
- Sides: PC



AJ23510

- Inox
- Laterales: PC
- Stainless Steel
- Sides: PC

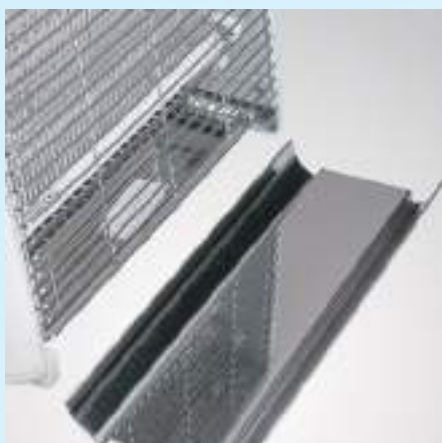

AJ54010

- Inox
- Laterales: PC
- Stainless Steel
- Sides: PC



AJ55010

- Inox
- Laterales: PC
- Stainless Steel
- Sides: PC



AJ56010

- Inox
- Laterales: PC
- Stainless Steel
- Sides: PC



AJ57010

- Inox
- Laterales: PC
- Stainless Steel
- Sides: PC

Características Técnicas Technical Characteristics		AJ21510	AJ22010	AJ22510	AJ23510	AJ54010	AJ55010	AJ56010	AJ57010
Peso Neto Net Weight	(Kg)	4,932	2,375	4,145	5,475	7,025	8,355	7,815	9,135
Peso Bruto Gross Weight	(Kg)	4,995	2,545	4,675	6,180	7,850	9,410	8,670	10,190
Tensión Tension	(V)	220 / 230	220 / 230	220 / 230	220 / 230	220 / 230	220 / 230	220 / 230	220 / 230
Frecuencia Frequency	(Hz)	50 / 60	50 / 60	50 / 60	50 / 60	50 / 60	50 / 60	50 / 60	50 / 60
Tubos Tubes	(n/W)	2 / 8	1 / 11	2 / 11	1 / 15	2 / 15	2 / 20	3 / 15	3 / 20
Potencia Power	(W)	16	11	22	15	30	40	45	60
Rejilla Grid	(V)	3.000	3.000	3.000	3.000	5.000	5.000	5.000	5.000
Rejilla Grid	(A)	0,010	0,010	0,010	0,010	0,010	0,010	0,010	0,010
Área Area	(m ²)	200	150	250	200	400	500	500	700

● FIJACIÓN: Techo o Sobremesa. | FIXING: Ceiling or table.
● EMBALAJE: Unitario. | PACKAGING: Single.

● LIMPIEZA: Bayeta húmeda. No usar productos químicos.
CLEANING: Damp cloth. Don't use chemicals.

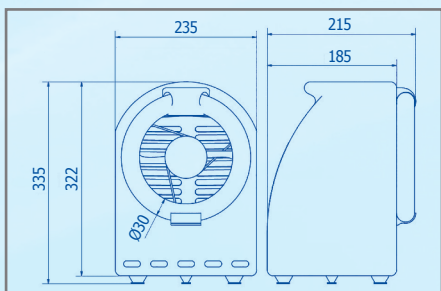

Dimensiones embalaje: (mm) 380
Packaging dimensions: 300 267

EXTERMINADOR INSECTOS POR ASPIRACIÓN INSECT KILLERS BY SUCTION

AJ36000

- Luz ultravioleta y ventilador aspiración.
- La luz atrae, el ventilador aspira.
- Depósito almacenaje insectos, integrado y cerrado.
- Silencioso, limpio y sin productos químicos.
- Velocidades: 2 (día/noche) con interruptor ON/OFF.
- Cable alimentación con enchufe.
- Ultraviolet light, fan with suction.
- Double action: light to attract, fan to suction.
- Deposit for insects integrated and closed.
- Quiet, clean, chemicals free.
- Speeds: 2 (day/night), ON/OFF switch.
- Power cable with plug.

Características Técnicas | Technical Characteristics

		AJ36000
Carcasa Cover		ABS
Color Colour		Gris Grey
Peso Neto/Bruto Net/Gross Weight	(Kg)	2,500 / 3,350
Tensión/Frecuencia Tension/Frequency	(V/Hz)	230 / 50
Tubos Tubes	(n/W)	1/32
Potencia Power	(W)	32
Aislamiento Insulation		Doble Double
R.P.M.		900 / 1.050
Área Area	(m ²)	20 / 25

- FIJACIÓN: Techo o Sobremesa. | FIXING: Ceiling or table.
- EMBALAJE: Unitario. | PACKAGING: Single.
- LIMPIEZA: Bayeta húmeda. No usar productos químicos. | CLEANING: Damp cloth. Don't use chemicals.

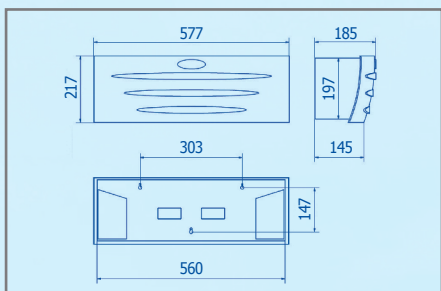

Dimensiones embalaje: (mm) 290
Packaging dimensions: 645 245

EXTERMINADOR INSECTOS POR ADHERENCIA ADHESIVE INSECT KILLERS

AJ60000

- Extermina por lámina adhesiva oculta.
- Tubos ultravioletas, ocultos.
- Carcasa ABS metalizada abatible y luminosa.
- Estructura metálica soportando carcasa y cable con enchufe.
- Lámina adhesiva JOFEL AKJ2000.
- Kills insects by means of hidden adhesive sheet.
- Ultraviolet lights hidden.
- External reclining cover of metallic ABS, with light.
- Metallic structure to fix cover and cable with plug.
- Adhesive sheet JOFEL AKJ2000.

Características Técnicas | Technical Characteristics

		AJ60000
Carcasa Cover		ABS
Acabado Finish		Gris Metalizado / Grey Metalised
Peso Neto/Bruto Net/Gross Weight	(Kg)	3,065 / 3,870
Tensión/Frecuencia Tension/Frequency	(V/Hz)	220 / 230 50 / 60
Tubos Tubes	(n/W)	2 / 15
Potencia Power	(W)	30
Área Area	(m ²)	50
Recambio Lámina Sheet Replacement		AKJ2000
Duración Lámina (días) Sheet life	(days)	30

- FIJACIÓN: 3 tornillos + 3 tacos (incluidos). Recomendado en lugares altos. | FIXING: 3 screws + 3 wall plugs (included). High places recommended.
- EMBALAJE: Unitario. | PACKAGING: Single.
- LIMPIEZA: Bayeta húmeda. No usar productos químicos. | CLEANING: Damp cloth. Don't use chemicals.

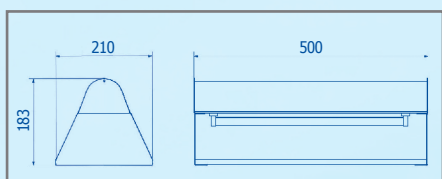

Dimensiones embalaje: (mm) $\begin{matrix} 215 \\ 260 \\ 535 \end{matrix}$

EXTERMINADOR INSECTOS POR ADHERENCIA ADHESIVE INSECT KILLERS

AJ80000

- Extermina por lámina adhesiva oculta.
- Tubo ultravioleta oculto. Área: 50 m²
- Carcasa Acero Inox Satinado y cable con enchufe.
- Lámina adhesiva JOFEL AKJ2000 (4 x 6 = 24; no incluida).
- Bandeja extraíble con lámina adhesiva.
- Kills insects by means of hidden adhesive sheet.
- Ultraviolet light hidden. Area 50 m²
- Cover Satin S.Steel and cable with plug.
- Adhesive sheet JOFEL AKJ2000 (4 x 6 = 24; no included).
- Removable tray with adhesive sheet.

Características Técnicas | Technical Characteristics

		AJ80000
Peso Neto/Bruto Net/Gross Weight	(Kg)	3,150 / 3,590
Tensión/Frecuencia Tension/Frequency	(V/Hz)	220-230 / 50-60
Tubo/Potencia Tube/Power	(n/W)	1 / 5

- FIJACIÓN: Techo o Sobremesa. | FIXING: Ceiling or Table.
- EMBALAJE: Unitario. | PACKAGING: Single.
- LIMPIEZA: Bayeta húmeda. No usar productos químicos. | CLEANING: Damp cloth. Don't use chemicals.

CONSUMIBLES > REFILLS



Dimensiones embalaje: (mm) $\begin{matrix} 150 \\ 265 \\ 65 \end{matrix}$



INSECTICIDA CONCENTRADO PIRETRINAS NATURALES NATURAL CONCENTRATED PYRETHRUM INSECTICIDE

AKI2002

- Con extracto de Pelitre, 100% natural.
- Muy efectivo por su alta concentración.
- Envase metálico con tapón protector.
- Válvula de seguridad con interrupción.
- Gas inocuo e inofensivo con componentes volátiles.
- Dosis de 0,065/0,075 ml aprox.
- Pyrethrum extract, 100% natural.
- Highly effective formula thanks to high concentration.
- Metal can with security lid.
- Security valve for automatic stop.
- Harmless and innocuous gas, volatile components.
- 0.065/0.075 ml per dose (approx).

Características Técnicas | Technical Characteristics

		AKI2002
Envase Container		Metálico / Metal
Peso Neto/Bruto Net/Gross Weight	(Kg)	0,240 / 0,250
Capacidad Volume	(L)	0,250
Dimensiones Dimensions	(mm)	147 x Ø65
Dosis Dose	(gr)	0,065 / 0,075

- EMBALAJE: 4 u. | PACKAGING: 4 u.



APLICACIÓN / USAGE

AKJ2000 ↔ AJ60000
AJ80000

RECAMBIOS LÁMINAS ADHESIVAS REFILLS ADHESIVE INSECT KILLERS

AKJ2000

- Duración aproximada 30 días.
- Con papel protector para evitar contacto manual.
- Higiénico y limpio.
- Peso lámina: 53 gr.
- Dimensiones: 1 x 40 x 19 mm.
- Embalaje: 4 blisters de 6 u. = 24 u.
- Lasts 30 days approximately
- With protection paper to prevent contact with hands.
- Hygienic, clean.
- Sheet weight: 53 gr.
- Dimensions: 1x 40 x 19
- Packaging: 4 bundles of 6 u. = 24 u.

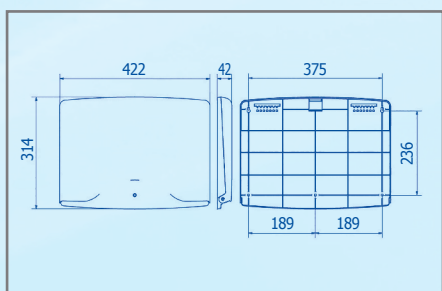

Dimensiones embalaje: (mm) 338
Packaging dimensions: 430 52

DISPENSADOR PAPEL CUBRE ASIENTOS W.C. "AZUR" "AZUR" TOILET SEAT COVER DISPENSERS

AM21000 - AM21500

- Fabricado en ABS blanco o metalizado.
- Dispensa unitariamente papel cubre-asientos WC.
- Cerradura con llave.
- Fácil limpieza, mantenimiento y recarga.
- Higiénicamente recomendado con carga AM20040 JOFEL.
- Uso Universal.
- Made of White ABS or Metalised.
- Dispenses single seat covers for WC.
- Key lock.
- Easy to clean, maintain and refill.
- Recommended for high hygiene, refill AM20040.
- Widespread use.



AM21000

- ABS Blanco
- White ABS



AM21500

- ABS Metalizado
- Metalised ABS

Características Técnicas Technical Characteristics	AM21000	AM21500
Peso Neto/Bruto Net/Gross Weight (Kg)	0,880 / 1,035	0,880 / 1,035
Servicios / Units.	125	125

- FIJACIÓN: 4 tornillos + 4 tacos (incluidos). | FIXING: 4 screws + 4 plugs (included).
- EMBALAJE: Unitario. | PACKAGING: Single.
- LIMPIEZA: Bayeta húmeda. No usar productos químicos. | CLEANING: Damp cloth. Don't use chemicals.

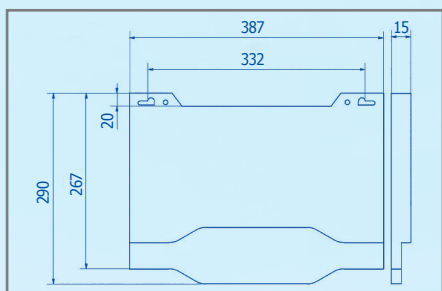
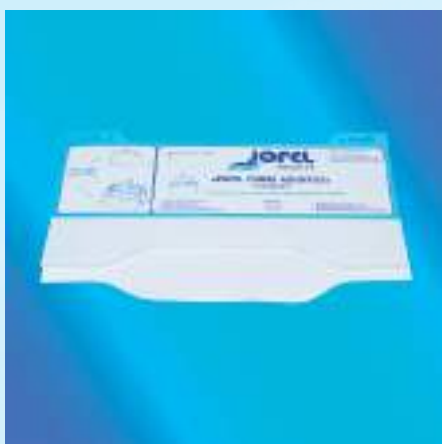

Dimensiones embalaje: (mm) 320
Packaging dimensions: 410 135

PAPEL CUBREASIENTOS WC TOILET SEAT COVER PAPER BOX

AM20040

- Higiénicamente recomendable.
- Estuche de cartón de 125 servicios.
- 70% Celulosa y 30% Reciclado.
- Color blanco satinado con RH.
- Dispensador unitario Jofel AM21000/21500.
- Uso Universal.
- Advisable for high hygiene.
- Package containing 125 services.
- 70% Cellulose and 30% Recycled.
- White satin finish MR.
- Suitable for Dispenser Jofel AM21000/21500.
- Widespread use.

Características Técnicas Technical Characteristics	AM20040
Material Material	Celulosa/Reciclado - 70%/30% Cellulose/Recycled - 70%/30%
Envase	Cartón / Paperboard
Peso Neto (12 u.) Net Weight (12 u.) (Kg)	4,260 (12 u.)
Peso Bruto (12 u.) Gross Weight (12 u.) (Kg)	4,540 (12 u.)
Servicios Envase Units Packaging	125
Servicios Embalaje Pieces Packaging	12 x 125 = 1.500

- UTILIZACIÓN: Dispensador JOFEL AM21000./21500 | USING: JOFEL Dispenser AM21000/21500.

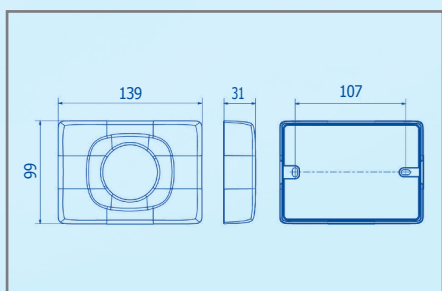

Dimensiones embalaje: (mm) 150
Packaging dimensions: 122 170

DISPENSADOR BOLSAS HIGIÉNICAS SANITARY BAGS DISPENSER

AM32000 - AM32800

- Dispensa bolsas unitariamente.
- Fabricado en ABS o Cromado.
- Fijado a pared por tacos y tornillos o adhesivo.
- Carga cartucho de 25 bolsas JOFEL AM30225 en "Z".
- Carcasa encajada a presión s/base.
- Orificio redondo central para dispensación.
- Single bag dispenser for sanitary towels.
- White or chromed ABS.
- Fixed to wall by screws and plugs or adhesive.
- Refills of 25 "Z"-fold bags, JOFEL reference AM30225.
- Cover pressed into base.
- Round central hole for dispensation.



AM32000

- ABS Blanco
- White ABS



AM32800

- ABS Cromado
- Chromed ABS

Características Técnicas Technical Characteristics	AM32000	AM32800
Carcasa Cover	ABS	ABS
Acabado Finish	Blanco / White	Cromado / Chromed
Base Base	ABS	ABS
Acabado Finish	Blanco / White	Blanco / White
Peso Neto Net Weight (gr)	90	100
Peso Bruto Gross Weight (5 u.) (gr)	500	550
Nº Bolsas Bags	25	25

- FIJACIÓN: 2 tornillos + 2 tacos (incluidos) o adhesivo. | FIXING: 2 screws + 2 wall plugs (included) or adhesive.
- EMBALAJE: 5 u. | PACKAGING: 5 u.
- LIMPIEZA: Bayeta húmeda. No usar productos químicos. | CLEANING: Damp cloth. Don't use chemicals.

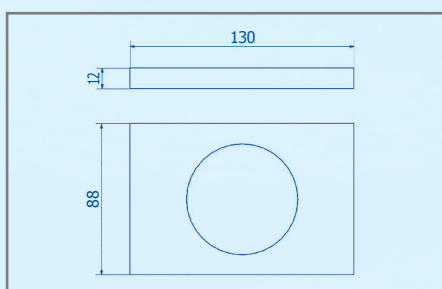

Dimensiones embalaje: (mm) 140
Packaging dimensions: 395 185

CARTUCHO BOLSAS HIGIÉNICAS SANITARY BAGS REFILL

AM30225

- Cartucho de cartón de 25 bolsas.
- Bolsas fabricadas en plástico HDPE.
- Orificio dispensador central redondo.
- Almacena y dispensa bolsas plegadas en "Z".
- Se utiliza en Dispensadores JOFEL AM32000/32800.
- Uso universal.
- Embalaje: 48 cartuchos.
- Cardboard cartridge containing 25 bags.
- Bags made of HDPE plastic.
- Round central hole for dispensation.
- Stores and dispenses "Z"-fold bags.
- To be used with JOFEL dispenser AM32000/32800.
- Widespread use.
- Packaging: 48 cartridges.

Características Técnicas Technical Characteristics	AM30225
Peso Neto Net Weight (gr)	0,035
Peso Bruto (48 c.) Gross Weight (48 c.) (gr)	1.800

- EMBALAJE: 48 cartuchos. | PACKAGING: 48 cartridges.
- TOTAL: 48 cartuchos x 25 bolsas = 1.200 bolsas. | TOTAL: 48 cartridges x 25 bags = 1.200 bags.

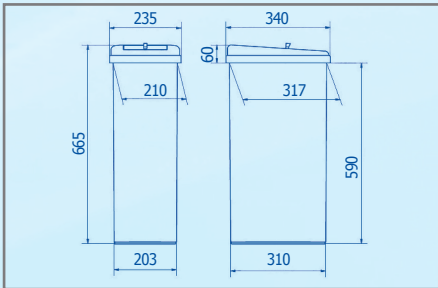

Dimensiones embalaje: (mm) 625
Packaging dimensions: 245 345

CONTENEDOR SANITARIO SANITARY CONTAINER

AM40000

- Contenedor para compresas femeninas.
- Fabricado en Polipropileno blanco.
- Trampilla superior en Inox.
- Cabezal superior extraíble.
- Apertura sin tocar la bandeja: higiénico.
- Ocultación contenido interior.
- Uso Universal.
- Feminine hygiene sanitary bin.
- Made of white Polypropylene.
- Top lid made of S. Steel.
- Removable top cover.
- Hygienic: can be opened without touching tray.
- Waste concealed inside.
- Widespread use.

Características Técnicas | Technical Characteristics

		AM40000
Carcasa Cover		Polipropileno / Polypropylene
Acabado Finish		Blanco / White
Peso Neto Net Weight	(Kg)	2,975
Peso Bruto Gross Weight	(Kg)	3,470
Capacidad Volume	(L)	40
Trampilla Hatch		Inox / S.Steel

- RECOMENDACIÓN: Utilizar anti-olor BIOJOFEL ref. AKM1001 en interior. | RECOMMENDED: BIOJOFEL ref. AKM1001.
- EMBALAJE: Unitario. | PACKAGING: Single.
- LIMPIEZA: Bayeta húmeda. No usar productos químicos. | CLEANING: Damp cloth. Don't use chemicals.

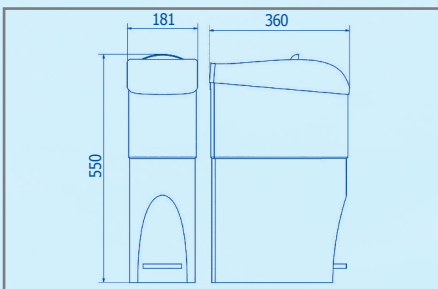

Dimensiones embalaje: (mm) 585
Packaging dimensions: 200 370

CONTENEDOR SANITARIO PEDAL SANITARY CONTAINER

AM41000

- Contenedor para compresas femeninas.
- Fabricado en Polipropileno blanco.
- Trampilla superior.
- Cabezal superior extraíble.
- Accionado por pedal.
- Apertura sin tocar la bandeja: higiénico.
- Ocultación contenido interior.
- Uso Universal.
- Feminine hygiene sanitary bin.
- Made of white Polypropylene.
- Small hatch at the top.
- Removable top cover.
- Pedal operated.
- Can be opened without touching tray: hygienic.
- Waste concealed inside.
- Widespread use.

Características Técnicas | Technical Characteristics

		AM41000
Carcasa Cover		Polipropileno / Polypropylene
Acabado Finish		Blanco / White
Peso Neto Net Weight	(Kg)	1,730
Peso Bruto Gross Weight	(Kg)	2,205
Capacidad Volume	(L)	15
Trampilla Hatch		Polipropileno / Polypropylene

- RECOMENDACIÓN: Utilizar anti-olor BIOJOFEL ref. AKM1001 en interior. | RECOMMENDED: BIOJOFEL ref. AKM1001.
- EMBALAJE: Unitario. | PACKAGING: Single.
- LIMPIEZA: Bayeta húmeda. No usar productos químicos. | CLEANING: Damp cloth. Don't use chemicals.

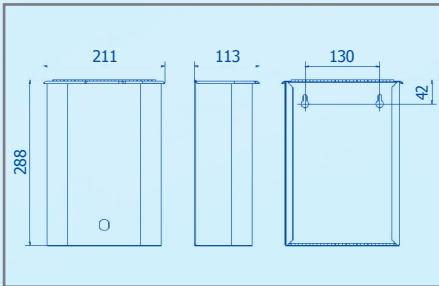

Dimensiones embalaje: (mm) 320
Packaging dimensions: 250 115

CONTENEDOR SANITARIO MURAL SANITARY BIN WALL MOUNTED

AM50000

- Fabricada en Acero Inox Satinado.
- Fijada a pared con tornillos y tacos.
- Cerrada y con tapa abatible.
- Base abatible con cerradura.
- Descarga fácil por parte inferior.
- Reducidas dimensiones y volumen.
- Diseño especial para espacios reducidos.
- Geometría redondeada evitando aristas.
- Recomendado: Biojofel AKM1001.
- Made of Stainless Steel, Satin finish.
- Fixed to wall by screws and wall plugs.
- Closed, with reclining cover.
- Swivel base with key lock.
- Easy to empty by lower part.
- Reduced dimensions and size.
- Especially designed for places with reduced dimensions.
- Rounded shape, without edges.
- Recommended: Biojofel AKM1001.

Características Técnicas | Technical Characteristics

		AM50000
Material Material		Inox / Stainless Steel
Acabado Finish		Satinado / Satin
Capacidad Volume	(L)	5
Peso Neto/Bruto Net/Gross Weight	(Kg)	1,190 / 1,335
Espesor Thickness	(mm)	0,8

- FIJACIÓN: 2 tornillos + 2 tacos (incluidos). | FIXING: 2 screws + 2 wall plugs (included).
- EMBALAJE: Unitario. | PACKAGING: Single.
- LIMPIEZ: Bayeta húmeda. No usar productos químicos. | CLEANING: Damp cloth. Don't use chemicals.

DISPENSADORES PAPEL CAMILLA > BEDDING PAPERS DISPENSERS

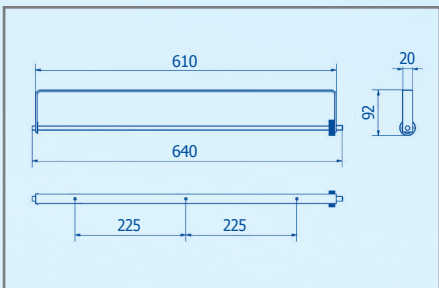

Dimensiones embalaje: (mm) 75
Packaging dimensions: 655 110

DISPENSADORES PAPEL CAMILLA BEDDING PAPER DISPENSERS

AN10000 - AN20000

- Barra soporte para bobina, de Acero Cromado.
- Dispensador de uso Universal.
- Para cualquier longitud de camilla.
- "Con" y "Sin" sierra para papel "Sin" o "Con" precorte.
- Se fija a camilla mediante tornillos.
- Perfecta higiene.
- Paper couch roll holder of Chromed Plated Steel.
- Widespread use dispenser.
- Adjustable to any couch length.
- Available with or without saw and suitable for both perforated and non-perforated paper.
- Fixed to couch by screws.
- Perfect hygien.



AN10000

- Acero Cromado
- Con Sierra
- Chromed Steel
- With Saw



AN20000

- Acero Cromado
- Sin Sierra
- Chromed Steel
- Without Saw

Características Técnicas | Technical Characteristics

		AN10000	AN20000
Peso Neto/Bruto Net/Gross Weight	(Kg)	1,490 / 1,630	0,680 / 2,170 (3 u.)
Ø Eje Ø Core	(mm)	9	9
Chapa Steel Sheet	(mm)	3	3

- FIJACIÓN: 4 tornillos + 4 tacos (incluidos). | FIXING: 4 screws + 4 plugs (included).
- EMBALAJE: Unitario. | PACKAGING: Single.
- LIMPIEZA: Bayeta húmeda. No usar productos químicos. | CLEANING: Damp cloth. Don't use chemicals.



Dimensiones embalaje: (mm) 195
Packaging dimensions: 255 255

APLICACIÓN / USAGE

- AKM1001 → AL36000
- AL36050
- AM40000
- AM41000
- AM50000

ELIMINADOR OLORES BIOJOFEL BAD SMELL KILLER AKM1001

- Eliminación por absorción de olores.
 - Pastilla sólida en bolsa porosa biodegradable.
 - Tratamiento enzimático, duración 4 semanas.
 - Tecnología lenta liberación olor cítrico.
 - Contiene fragancia y cultivo micro-organismos.
 - 1 Bolsa (20 gr) para volumen 15/20 L.
- Absorption of odours.
 - Solid tablet inside biodegradable porous bag.
 - Enzymatic treatment, lasts 4 weeks.
 - Technology consisting in slow release of citric odour.
 - Includes fragrance and micro-organism culture.
 - Each bag (20 gr) suitable for 15/20 L waste.

Características Técnicas | Technical Characteristics

		AKM1001
Cubo Cube		Plástico / Plastic
Peso Neto/Bruto Net/Gross Weight	(Kg)	3,000 / 3,925
Alto-Ancho-Fondo Height-Width-Depth	(mm)	195 x 255 x 255
Bolsa Bag	(gr)	20
Nº Bolsas Bags		150
Duración Bolsa (Semanas) Bag life (Weeks)		4
Uso Use		Profesional / Professional
Aplicaciones Usages		Universal

• EMBALAJE: Unitario. | PACKAGING: Single.



Dimensiones embalaje: (mm) 145
Packaging dimensions: 185 280

APLICACIÓN / USAGE

- AKB4001 → AI85000
- AKB4002

CARGAS BACTERIOSTÁTICAS REFILL URINARY DISINFECTION AKB4001 - AKB5001

- Limpian, higienizan, desinfectan y olorizan.
 - Envase plástico rígido: 4.000 dosis.
 - Envase de 500 ml. Dosis de 0,125 ml.
 - Uso exclusivo Jofel AI85000.
 - Válvula seguridad y tapón protector.
 - Elimina gérmenes y bacterias.
- Cleans, sanitises, disinfects and perfumes.
 - Rigid plastic bottle: 4.000 doses.
 - 0,125 ml/dose, 500 ml bottle.
 - Exclusive use Jofel AI8500.
 - Security valve, protection plastic lid.
 - Kills germs and bacteria.



AKB4001

- Plástico
- Plastic



AKB5001

- Plástico
- Plastic

Características Técnicas | Technical Characteristics

	AKB4001	AKB5001
Peso Neto/Bruto Net/Gross Weight	(Kg) 0,555 / 3,515 (6u.)	0,555 / 3,515 (6u.)
Dimensiones Dimensions	(mm) 130 x 85 x 90	130 x 85 x 90
Color Cargas Refills Colour	Incoloro / No color	Incoloro / No color
Capacidad Volume	(L) 0,500	0,500
Dosis Doses	(ml) 0,125	0,125
Descargas Discharges	4.000	4.000
Olor Odour	Marino / Sea	Naranja / Orange

• Uso exclusivo Bacteriostático JOFEL AI85000. | Exclusive use Bacteriostatic JOFEL AI85000.
• EMBALAJE: 6 u. | PACKAGING: 6 u.



AZUR / FUTURA

AT10000 FOAM	→	AC40000	1 L
		AC45000	1 L
		AC45500	1 L



AZUR / FUTURA

AT14000 FOAM	→	AC41000	0,80 L
AT14500 SPRAY	→	AC46000	0,80 L
AT14700 FOAM	→	AC46500	0,80 L



AZUR

AT16000 FOAM	→	AC91000	0,80 L
AT16500 SPRAY			
AT16700 FOAM			



AZUR / FUTURA

AT51280 GEL	→	AC53000	0,80 L
AT51380 GEL	→	AC53500	0,80 L
AT51580 GEL		AC80000	0,80 L
AT96000 HYDROALC.		AC81200	0,80 L
		AC81400	0,80 L



SMART

AT52280 GEL			
AT52380 GEL	→	AC96500	0,80 L
AT52580 GEL	→	AC27000	0,80 L
AT95000 HYDROALC.			



AZUR

AT53280 GEL			
AT53380 GEL	→	AC91000	0,80 L
AT53580 GEL			



BASIC

AKA2001			
AKA2002			
AKA2003			
AKA2004	→	AI90000	0,25 L
AKA2015			
AKA2016			
AKA2020			
AKA2021			



BASIC

AKI2002			0,25 L
---------	--	--	--------



ATLÁNTICA / ATLANTICA

AKB4001	→	AI85000	0,50 L
AKB5001			

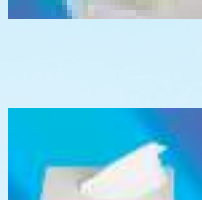

ADHESIVO / ADHESIVE

AKJ2000	→	AJ60000	4x6 = 24 u
		AJ80000	4x6 = 24 u



ATLÁNTICA / ATLANTICA

AKM1001	→	AL36000	150 u
		AL36050	150 u
		AM40000	150 u
		AM41000	150 u



CUBREASIENTOS / TOILET SEET COVER

AM20040	→	AM21000	125 u
		AM21500	125 u

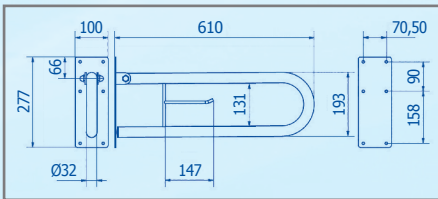

Dimensiones embalaje: (mm) 290
Packaging dimensions: 625 120

- FIJACIÓN: A pared mediante placa acero Inox. con 6 tornillos + 6 tacos (incluidos). | FIXING: S. Steel license plate fixed to wall with 6 screws + 6 wall plugs (included).
- EMBALAJE: Unitario. | PACKAGING: Single.
- LIMPIEZA: Bayeta húmeda. No usar productos químicos. | CLEANING: Damp cloth. Don't use chemicals.

BARRA ABATIBLE DOBLE DOUBLE RECLINING BARS

AV10600 - AV10700 - AV14700 - AV10840 - AV14840

- Barra abatible doble en forma de "U"
- Fabricada en Inox.
- Incorpora guía para rollo higiénico.
- Antivandálica.
- Guía de refuerzo vertical.
- Robusta, resistente y adaptable.
- Fijada a pared con placa atornillada.
- Reclining safety rail, "U" shape
- Made of Stainless Steel.
- Includes holder for toilet tissue roll
- Antivandalism
- Reinforcement bar between sides.
- Sturdy, resistant and adaptable.
- Fixed by means of a plate screwed to wall.



AV10600 (Lamas/Notches)



AV10700 (Lamas/Notches)
AV14700 (Lisa/Smooth)



AV10840 (Lamas/Notches)
AV14840 (Lisa/Smooth)

Características Técnicas Technical Characteristics	AV10600	AV10700	AV14700	AV10840	AV14840
Material Material	Inox / S.Steel	Inox / S.Steel	Inox / S.Steel	Inox / S.Steel	Inox / S.Steel
Acabado Finish	Brillo / Bright	Brillo / Bright	Satinado / Satin	Brillo / Bright	Satinado / Satin
Peso Neto/Bruto Net/Gross Weight (Kg)	1,945 / 2,300	2,105 / 2,500	2,105 / 2,500	2,345 / 2,800	2,320 / 2,780
Long. Barra/Ø Barra Bar Length/Ø Bar (mm)	600 / 32	700 / 32	700 / 32	840 / 32	840 / 32
Peso Soportado Weight Bearing (Kg)	120	120	120	120	120
Distancia entre Barras Distance between Bars (mm)	200	200	200	200	200

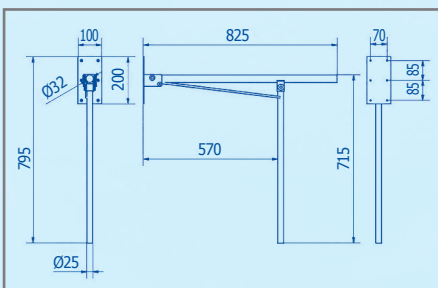

Dimensiones embalaje: (mm) 210
Packaging dimensions: 900 110

BARRA ABATIBLE PIE RECLINING BARS WITH LEG

AV10830 - AV14830

- Barra abatible con apoyo en "T".
- Fabricada en Inox.
- Fijada a pared mediante placa atornillada.
- Antivandálica.
- Plegado automático del pie de apoyo.
- Robusta, resistente y adaptable.
- Plegada a pared.
- Reclining support rail with "T".
- Made of Stainless Steel.
- Fixed by means of a plate screwed to wall.
- Antivandalism.
- Leg folds automatically.
- Robust, resistant and adaptable.
- Folded up to wall.



AV10830

- Acero Inox Brillo
- Lamas
- Bright Stainless Steel
- Notches



AV14830

- Acero Inox Satinado
- Lisa
- Satin Stainless Steel
- Smooth

Características Técnicas Technical Characteristics	AV10830	AV14830
Peso Neto/Bruto Net/Gross Weight (Kg)	2,220 / 2,630	2,220 / 2,630
Ø Brazo/Apoyo Ø Arm/Support (mm)	32 / 25	32 / 25
Peso Soportado Weight Bearing (Kg)	120	120
Long. Barra Bar Length (mm)	825	825
Espesor Tubo Tube Thickness (mm)	1,2	1,2

- FIJACIÓN: A pared mediante placa acero Inox. con 6 tornillos + 6 tacos (incluidos). | FIXING: S. Steel license plate fixed to wall with 6 screws + 6 wall plugs (included).
- EMBALAJE: Unitario. | PACKAGING: Single.
- LIMPIEZA: Bayeta húmeda. No usar productos químicos. | CLEANING: Damp cloth. Don't use chemicals.

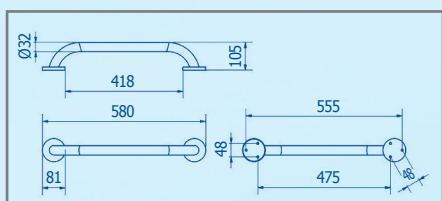

Dimensiones embalaje: (mm) $\begin{matrix} 87 \\ 595 \end{matrix}$

- FIJACIÓN: 6 tornillos + 6 tacos (incluidos). | FIXING: 6 screws + 6 wall plugs (included).
- EMBALAJE: Unitario. | PACKAGING: Single.
- LIMPIEZA: Bayeta húmeda. No usar productos químicos. | CLEANING: Damp cloth. Don't use chemicals.

BARRA FIJA PARED

FIXED GRAB BAR, WALL MOUNTED

AV40320 - AV40400 - AV40500 - AV40600 - AV40800

- Barra sujeción con fijación doble.
- Fabricada en Inox.
- Con muescas antideslizantes.
- Obligatoria según normativa oficial.
- Tornillos fijación ocultos en la corona.
- Robustas, resistentes y fácil mantenimiento.
- Uso Universal.
- Grab rail, double fixing.
- Made of Stainless Steel.
- Anti-slip knurled handle.
- In compliance with legal regulations.
- Screws concealed at both ends.
- Sturdy, resistant, easy to maintain.
- Widespread use.



AV40320 (Lamas/Notches)
AV40400 (Lamas/Notches)

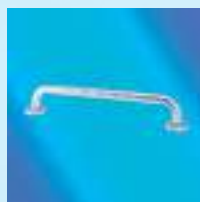

AV40500 (Lamas/Notches)
AV40600 (Lamas/Notches)

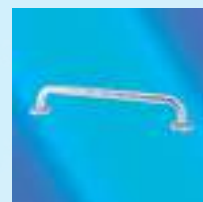

AV40800 (Lamas/Notches)

Características Técnicas Technical Characteristics	AV40320	AV40400	AV40500	AV40600	AV40800
Material Material	Inox / S.Steel	Inox / S.Steel	Inox / S.Steel	Inox / S.Steel	Inox / S.Steel
Acabado Finish	Brillo / Bright	Brillo / Bright	Brillo / Bright	Brillo / Bright	Brillo / Bright
Peso Neto/Bruto Net/Gross Weight (Kg)	0,545 / 0,680	0,625 / 0,770	0,690 / 0,865	0,790 / 0,995	0,935 / 1,165
Long./Ø Barra Length/Ø Bar (mm)	320 / 32	400 / 32	500 / 32	600 / 32	800 / 32
Espesor Tubo Tube Thickness (mm)	1,2	1,2	1,2	1,2	1,2

BARRA FIJA PARED

FIXED GRAB BAR, WALL MOUNTED

AV44320 - AV44400 - AV44500 - AV44600 - AV44800

- Barra lisa sujeción, con fijación doble.
- Fabricada en Inox.
- Obligatoria según normativa oficial.
- Robustas, resistentes y fácil mantenimiento.
- Tornillos fijación, ocultos en la corona.
- Corona en ambos extremos.
- Uso Universal.
- Smooth grab rail, double fixing.
- Made of S. Stainless.
- In compliance with legal regulations.
- Sturdy, resistant and easy to maintain.
- Screws concealed at both ends.
- Steel plates at both ends.
- Widespread use.

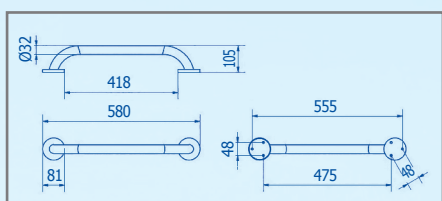

Dimensiones embalaje: (mm) $\begin{matrix} 85 \\ 410 \end{matrix}$

- FIJACIÓN: 6 tornillos + 6 tacos (incluidos). | FIXING: 6 screws + 6 wall plugs (included).
- EMBALAJE: Unitario. | PACKAGING: Single.
- LIMPIEZA: Bayeta húmeda. No usar productos químicos. | CLEANING: Damp cloth. Don't use chemicals.



AV44320 (Lisa/Smooth)
AV44400 (Lisa/Smooth)



AV44500 (Lisa/Smooth)
AV44600 (Lisa/Smooth)



AV44800 (Lisa/Smooth)

Características Técnicas Technical Characteristics	AV40320	AV40400	AV40500	AV40600	AV40800
Material Material	Inox / S.Steel	Inox / S.Steel	Inox / S.Steel	Inox / S.Steel	Inox / S.Steel
Acabado Finish	Satinado / Satin	Satinado / Satin	Satinado / Satin	Satinado / Satin	Satinado / Satin
Peso Neto/Bruto Net/Gross Weight (Kg)	0,620 / 0,760	0,670 / 0,830	0,690 / 0,870	0,825 / 1,045	0,990 / 1,235
Long./Ø Barra Length/Ø Bar (mm)	320 / 32	400 / 32	500 / 32	600 / 32	800 / 32
Espesor Tubo Tube Thickness (mm)	1,2	1,2	1,2	1,2	1,2



BARRA SUJECIÓN ANGULAR CORNER GRAB BAR AV60600 - AV70400

- Tubo liso Inox AISI 304, Satinado.
- Antivadálica e higiénica.
- Puntos de fijación a pared: 3 con 3 tornillos.
- Tornillos de fijación ocultos por la corona.
- De conformidad con la legislación vigente.

- Smooth tube, made of S. Steel AISI 304, Satin finish.
- Antivandal and hygienic.
- Fixing points to wall: 3 with 3 screws.
- Screws concealed at ends.
- In compliance with legal regulations.

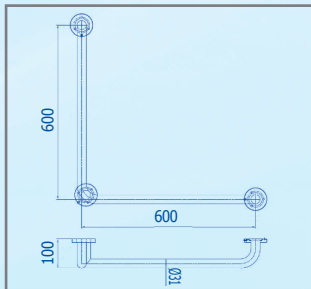

AV60600

Dimensiones embalaje:
Packaging dimensions:

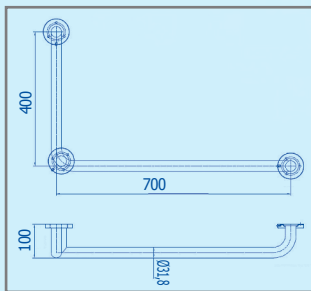
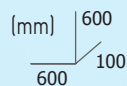

AV70400

Dimensiones embalaje:
Packaging dimensions:

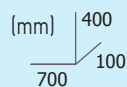

AV60600

- Acero Inox Satinado
- Satin Stainless Steel

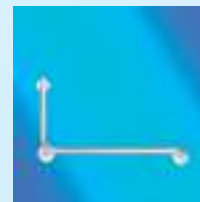

AV70400

- Acero Inox Satinado
- Satin Stainless Steel

Características Técnicas Technical Characteristics	AV60600	AV70400
Ø Tubo Ø Tube (mm)	31,8	31,8
Espesor Tubo Tube Thickness (mm)	1,2	1,2
Peso Neto/Bruto Net/Gross Weight (Kg)	1,450 / 1,500	1,400 / 1,450
Long. Barra Length Bar (mm)	600 x 600	700 x 400

- FIJACIÓN: 9 tornillos + 9 tacos (incluidos). | FIXING: 9 screws + 9 wall plugs (included).
- EMBALAJE: Unitario. | PACKAGING: Single.
- LIMPIEZA: Bayeta húmeda. No usar productos químicos. | CLEANING: Damp cloth. Don't use chemicals.

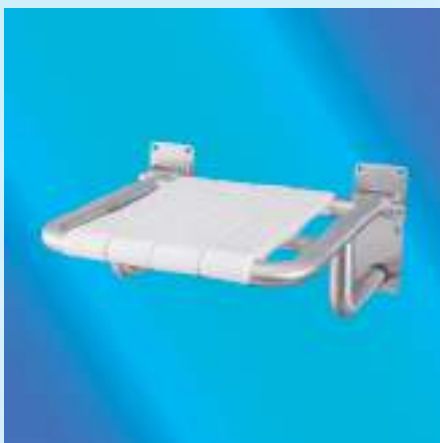

ASIENTO DUCHA SHOWER SEAT AV84400

- Estructura Acero Inox.
- Asiento abatible con láminas de Vinilo higiénico.
- Material biocompatible, antialérgico y antideslizante.
- Codo inferior de apoyo a pared.
- Soporta peso hasta 120 Kg.
- Fijado a pared mediante placa atornillada.
- Uso Universal.

- Stainless Steel structure
- Folding seat made of hygienic Vinyl.
- Biocompatible, antiallergic and nonslip material
- Elbow shaped support leaning against wall.
- Weight limit 120 kg approximately
- Fixed to wall by means of screwed plate
- Widespread use.

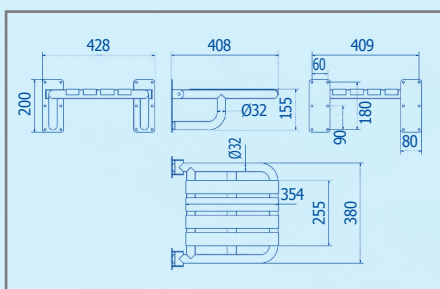

Dimensiones embalaje: (mm) 225
Packaging dimensions: 455 445

Características Técnicas Technical Characteristics	AV84400
Material Material	Inox / S. Steel
Acabado Finish	Satinado / Satin
Peso Neto Net Weight (Kg)	3,700
Peso Bruto Gross Weight (Kg)	4,575
Ø Tubo Ø Tube (mm)	32
Espesor Tubo Tube Thickness (mm)	1,2

- FIJACIÓN: 12 tornillos + 12 tacos (incluidos). | FIXING: 12 screws + 12 wall plugs (included).
- EMBALAJE: Unitario. | PACKAGING: Single.
- LIMPIEZA: Bayeta húmeda. No usar productos químicos. | CLEANING: Damp cloth. Don't use chemicals.

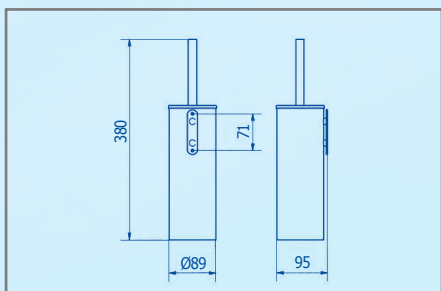

Dimensiones embalaje: (mm) 405
Packaging dimensions: 96 96

ESCOBILLERO TOILET BRUSH AW61000 - AW62000

- Fabricado en Inox.
- Tapa integrada en mango.
- Ocultación interior.
- Versátil: opción de fijarse a pared o suelo.
- Antivandálico.
- Geometría cilíndrica.
- Fácil mantenimiento y limpieza.
- Uso Universal.

- Made of Stainless Steel.
- Holder integrated on cover.
- Brush hidden inside.
- Versatile: can be fixed to wall or floor standing.
- Antivandalism.
- Cylindrical shape.
- Easy to clean and maintain.
- Widespread use.



AW61000

- Acero Inox Brillo
- Bright Stainless Steel



AW62000

- Acero Inox Satinado
- Satin Stainless Steel

Características Técnicas Technical Characteristics	AW61000	AW62000
Peso Neto/Bruto Net/Gross Weight (Kg)	0,780 / 0,915	0,795 / 0,935

- FIJACIÓN: A pared o suelo. 2 tornillos, 2 soportes pared, 2 tacos (incluidos). | FIXING: Wall or floor, with 2 screws, 2 wall supports, 2 wall plugs (included).
- EMBALAJE: Unitario. | PACKAGING: Single.
- LIMPIEZA: Bayeta húmeda. No usar productos químicos. | CLEANING: Damp cloth. Don't use chemicals.

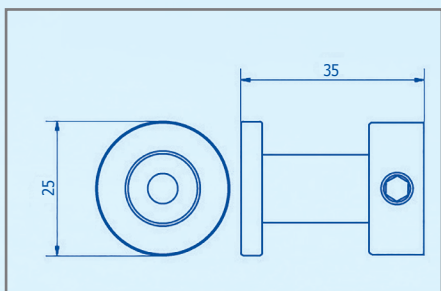

Dimensiones embalaje: (mm) 80
Packaging dimensions: 92 77

PERCHA UNITARIA SINGLE TOWEL HANGER AW21000 - AW21300

- Colgador cilíndrico con soporte.
- Antivandálica.
- Tornillo fijación a pared, oculto por embellecedor.
- Funcional, sencilla, elegante y moderna.
- Fácil limpieza y mantenimiento.
- Mínimo espacio.

- Cylindrical hook with support.
- Antivandalism.
- Fixed to wall by means of 1 screw, concealed by support.
- Functional, simple, elegant and modern.
- Easy to clean and maintain.
- Reduced dimensions.



AW21000

- Acero Inox Satinado
- Satin Stainless Steel



AW21300

- Latón Cromado Brillo
- Bright Chromed Brass

Características Técnicas Technical Characteristics	AW21000	AW21300
Peso Neto/Bruto Net/Gross Weight (Kg)	0,065 / 0,095	0,065 / 0,095

- FIJACIÓN: Mediante 1 tornillo + 1 taco (incluidos). | FIXING: 1 screw + 1 wall plug (included).
- EMBALAJE: Unitario. | PACKAGING: Single.
- LIMPIEZA: Bayeta húmeda. No usar productos químicos. | CLEANING: Damp cloth. Don't use chemicals.



PERCHA DOBLE / DOUBLE TOWEL HANGER AW22000 - AW22300

- Colgador cilíndrico con doble soporte.
- Antivandálica.
- Tornillo fijación a pared, oculto por embellecedor.
- Funcional, sencilla, elegante y moderna.
- Fácil limpieza y mantenimiento.
- Mínimo espacio.
- Cylindrical double hook rack.
- Antivandalism.
- Screw for wall fixing, concealed by support.
- Functional, simple, elegant and modern.
- East to clean and maintain.
- Reduced dimensions.

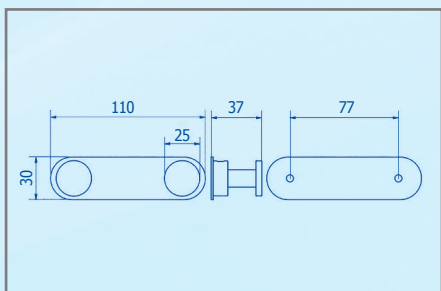

Dimensiones embalaje: (mm) $\begin{matrix} 68 \\ 104 \\ 70 \end{matrix}$
Packaging dimensions:



AW22000

- Acero Inox Satinado
- Satin Stainless Steel



AW22300

- Latón Cromado Brillo
- Bright Chromed Brass

Características Técnicas Technical Characteristics	AW22000	AW22300
Peso Neto/Bruto Net/Gross Weight (Kg)	0,175 / 0,210	0,175 / 0,210

- FIJACIÓN: 2 tornillos + 2 tacos (incluidos). | FIXING: 2 screws + 2 wall plugs (included).
- EMBALAJE: Unitario. | PACKAGING: Single.
- LIMPIEZA: Bayeta húmeda. No usar productos químicos. | CLEANING: Damp cloth. Don't use chemicals.



TOALLERO / TOWEL BAR AW10330 - AW10340 - AW10360

- Barra redonda en forma de "U".
- Latón cromado brillo.
- Antivandálico.
- Fijado a pared mediante tacos y tornillos ocultos.
- Corona envolvente en sus extremos, oculta tornillos.
- Funcional, elegante y moderna.
- Round bar, "U" shape.
- Chrome plated brass, bright finish.
- Antivandalism.
- Fixed to wall by means of screws and wall plugs concealed.
- Steel plates at both ends to hide screws.
- Functional, elegant and modern.

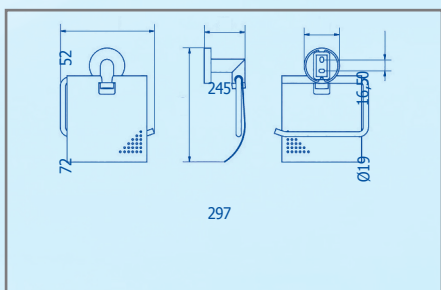

Dimensiones embalaje: (mm) $\begin{matrix} 78 \\ 518 \\ 79 \end{matrix}$
Packaging dimensions:



AW10330

- Latón Cromado Brillo
- Bright Chromed Brass



AW10340

- Latón Cromado Brillo
- Bright Chromed Brass



AW10360

- Latón Cromado Brillo
- Bright Chromed Brass

Características Técnicas Technical Characteristics	AW10330	AW10340	AW10360
Material Material	Latón / Brass	Latón / Brass	Latón / Brass
Acabado Finish	Cromado Brillo Bright Chromed	Cromado Brillo Bright Chromed	Cromado Brillo Bright Chromed
Peso Neto/Bruto Net/Gross Weight (Kg)	0,280 / 0,390	0,300 / 0,415	0,365 / 0,520
Long. Length (mm)	300	400	600
Ø Tubo Ø Tube (mm)	19	19	19

- FIJACIÓN: 4 tornillos + 4 tacos (incluidos). | FIXING: 4 screws + 4 plugs (included).
- EMBALAJE: Unitario. | PACKAGING: Single.
- LIMPIEZA: Bayeta húmeda. No usar productos químicos. | CLEANING: Damp cloth. Don't use chemicals.

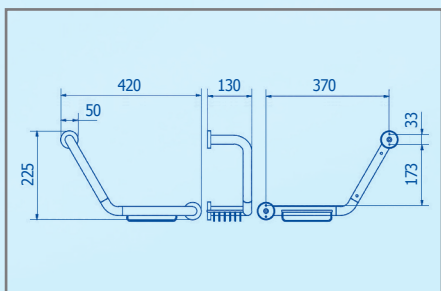

Dimensiones embalaje: (mm) 141
Packaging dimensions: 470 134

MANILLÓN ANGULAR C/JABONERA CORNER HANDLE W/SOAP DISPENSER AW11300

- Accesorio mixto de barra y jabonera.
- Barra redonda fijada a pared.
- Tornillos fijación ocultos por corona envolvente.
- Antivandálico.
- Versátil: rejilla jabonera desmontable.
- Rejilla jabonera intercambiable.
- Intercambiable: derecha o izquierda.
- Mixed accessory: grab rail and soap dish.
- Round grab rail fixed to wall.
- Fixing screws concealed by support.
- Antivandalism.
- Versatile: detachable soap dish.
- Interchangeable soap dish.
- Interchangeable: right or left.

Características Técnicas | Technical Characteristics

Características Técnicas Technical Characteristics		AW11300
Material Material		Latón / Brass
Acabado Finish		Cromado Brillo / Bright Chromed
Peso Neto Net Weight	(Kg)	0,735
Peso Bruto Gross Weight	(Kg)	0,920
Ø Tubo Ø Tube	(mm)	25

- FIJACIÓN: 4 tornillos + 4 tacos (incluidos). | FIXING: 4 screws + 4 plugs (included).
- EMBALAJE: Unitario. | PACKAGING: Single.
- LIMPIEZA: Bayeta húmeda. No usar productos químicos. | CLEANING: Damp cloth. Don't use chemicals.

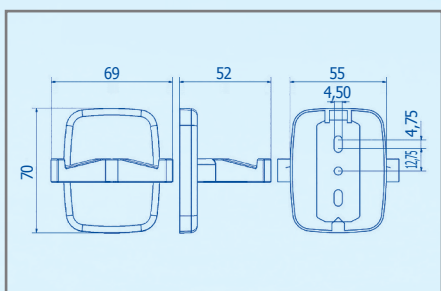

Dimensiones embalaje: (mm) 81
Packaging dimensions: 92 77

PERCHA DOBLE EN GANCHO DOUBLE TOWEL HANGER AW23300

- Colgador doble con soporte único.
- Terminada en garfio doble.
- Antivandálica.
- Fijada a pared mediante tornillos ocultos.
- Tapa adosada a pared que oculta tornillos.
- Funcional, sencilla, elegante y moderna.
- Double wall hanger with single support.
- Double hook.
- Antivandalism.
- Fixed to wall by means of screws, concealed fixing.
- Support fixed to wall concealing screws.
- Functional, simple, elegant and modern.

Características Técnicas | Technical Characteristics

Características Técnicas Technical Characteristics		AW23300
Material Material		Latón / Brass
Acabado Finish		Cromado Brillo / Bright Chromed
Peso Neto Net Weight	(Kg)	0,105
Peso Bruto Gross Weight	(Kg)	0,135
Colgadores: Ganchos Hangers: Hooks		2

- FIJACIÓN: 4 tornillos + 4 tacos (incluidos). | FIXING: 4 screws + 4 plugs (included).
- EMBALAJE: Unitario. | PACKAGING: Single.
- LIMPIEZA: Bayeta húmeda. No usar productos químicos. | CLEANING: Damp cloth. Don't use chemicals.

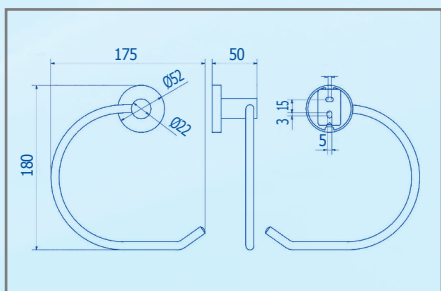

Dimensiones embalaje: (mm) 181
Packaging dimensions: 183 62

ANILLA TOALLERO ABIERTA OPEN TOWEL RING AW31300

- Perfil cilíndrico.
- Abierta para toallas.
- Antivandálica.
- Fijada a pared mediante tornillos ocultos.
- Funcional, sencilla, elegante y moderna.
- Fácil limpieza y mantenimiento.
- Giratoria.
- Base plana.
- Cylindrical contour.
- Open ring, for towels.
- Antivandalism.
- Fixed to wall by means of screws, concealed by support.
- Functional, simple, elegant and modern.
- Easy to clean and maintain.
- Swivel.
- Flat base.

Características Técnicas Technical Characteristics	AW31300
Material Material	Latón / Brass
Acabado Finish	Cromado Brillo / Bright Chromed
Peso Neto Net Weight (Kg)	0,365
Peso Bruto Gross Weight (Kg)	0,440

- FIJACIÓN: 2 tornillos + 2 tacos (incluidos). | FIXING: 2 screws + 2 wall plugs (included).
- EMBALAJE: Unitario. | PACKAGING: Single.
- LIMPIEZA: Bayeta húmeda. No usar productos químicos. | CLEANING: Damp cloth. Don't use chemicals.

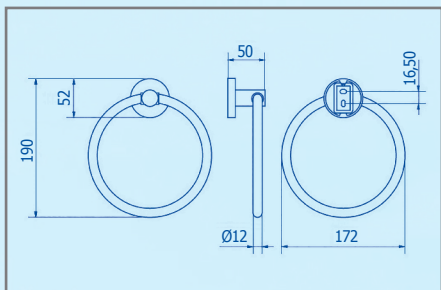

Dimensiones embalaje: (mm) 80
Packaging dimensions: 92 77

ANILLA TOALLERO CERRADA CLOSED TOWEL HOLDER RING AW34300

- Perfil cilíndrico.
- Cerrada para toallas.
- Antivandálica.
- Fijada a pared mediante tornillos ocultos por embellecedor.
- Funcional, sencilla, elegante y moderna.
- Fácil limpieza y mantenimiento.
- Giratoria.
- Cylindrical contour.
- Closed ring for towels.
- Antivandalism.
- Fixed to wall by means of screws, concealed fixing.
- Functional, simple, elegant and modern.
- Easy to clean and maintain.
- Swivel.

Características Técnicas Technical Characteristics	AW34300
Material Material	Latón / Brass
Acabado Finish	Cromado Brillo / Bright Chromed
Peso Neto Net Weight (Kg)	0,245
Peso Bruto Gross Weight (Kg)	0,315

- FIJACIÓN: 2 tornillos + 2 tacos (incluidos). | FIXING: 2 screws + 2 wall plugs (included).
- EMBALAJE: Unitario. | PACKAGING: Single.
- LIMPIEZA: Bayeta húmeda. No usar productos químicos. | CLEANING: Damp cloth. Don't use chemicals.

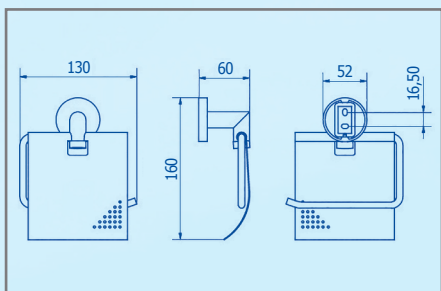

Dimensiones embalaje: (mm) 151
Packaging dimensions: 130 81

PORTARROLLO CON TAPA TOILET ROLL HOLDER WITH COVER AW41300

- Soporte rollo papel higiénico.
- Con tapa.
- Antivandálico.
- Fijación a pared mediante tornillos ocultos.
- Tapa abatible ajustada al papel.
- Funcional, sencilla, elegante y moderna.
- Toilet tissue roll holder.
- With cover.
- Antivandalism.
- Fixed to wall by means of screws, concealed fixing.
- Reclining cover adjustable to roll.
- Functional, simple, elegant and modern.

Características Técnicas | Technical Characteristics

		AW41300
Material Material		Latón / Brass
Acabado Finish		Cromado Brillo / Bright Chromed
Peso Neto Net Weight	(Kg)	0,340
Peso Bruto Gross Weight	(Kg)	0,405
Nº Rollos Rolls		1

- FIJACIÓN: 2 tornillos + 2 tacos (incluidos). | FIXING: 2 screws + 2 wall plugs (included).
- EMBALAJE: Unitario. | PACKAGING: Single.
- LIMPIEZA: Bayeta húmeda. No usar productos químicos. | CLEANING: Damp cloth. Don't use chemicals.

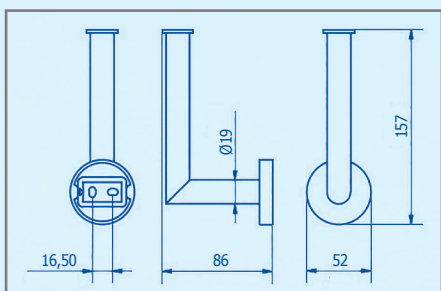

Dimensiones embalaje: (mm) 151
Packaging dimensions: 130 81

PORTARROLLO RESERVA SPARE TOILET ROLL HOLDER AW42300

- Soporte para papel higiénico de reserva.
- Con remate superior.
- Antivandálico.
- Fijado a pared mediante tornillos ocultos.
- Funcional, sencillo, elegante y moderno.
- Fácil limpieza y mantenimiento.
- Reserve toilet tissue roll holder.
- Wider top.
- Antivandalism.
- Fixed to wall by means of screws, concealed by support.
- Functional, simple, elegant and modern.
- Easy to clean and maintain.

Características Técnicas | Technical Characteristics

		AW42300
Material Material		Latón / Brass
Acabado Finish		Cromado Brillo / Bright Chromed
Peso Neto Net Weight	(Kg)	0,165
Peso Bruto Gross Weight	(Kg)	0,225
Nº Rollos Rolls		1

- FIJACIÓN: 2 tornillos + 2 tacos (incluidos). | FIXING: 2 screws + 2 wall plugs (included).
- EMBALAJE: Unitario. | PACKAGING: Single.
- LIMPIEZA: Bayeta húmeda. No usar productos químicos. | CLEANING: Damp cloth. Don't use chemicals.



PORTARROLLO RESERVA DOBLE DOUBLE SPARE TOILET ROLL HOLDER AW43300

- Soporte doble para papel higiénico de reserva.
 - Con remate en extremo.
 - Antivandálico en forma de "T".
 - Fijado a pared mediante tornillos ocultos.
 - Funcional, sencillo, elegante y moderno.
 - Fácil limpieza y mantenimiento.
- Double holder for reserve toilet tissue roll.
 - Ending part at the edge of the bar.
 - Antivandalism, "T" shape.
 - Fixed to wall by means of concealed screws.
 - Functional, simple, elegant and modern.
 - Easy to clean and maintain.

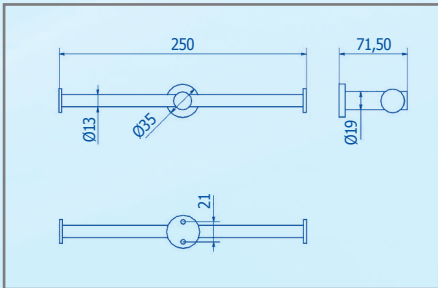

Dimensiones embalaje: (mm) 260
Packaging dimensions: 163 70

Características Técnicas Technical Characteristics		AW43300
Material Material		Latón / Brass
Acabado Finish		Cromado Brillo / Bright Chromed
Peso Neto Net Weight	(Kg)	0,265
Peso Bruto Gross Weight	(Kg)	0,355
Nº Rollos Rolls		1

- FIJACIÓN: 2 tornillos + 2 tacos (incluidos). | FIXING: 2 screws + 2 wall plugs (included).
- EMBALAJE: Unitario. | PACKAGING: Single.
- LIMPIEZA: Bayeta húmeda. No usar productos químicos. | CLEANING: Damp cloth. Don't use chemicals.



REPISA TOALLERO TOWEL SHELF AW51300

- Plataforma rectangular.
 - Doble estante de diferente fondo.
 - Con barras para toallas.
 - Antivandálica.
 - Fijada a pared mediante tornillos ocultos.
 - Funcional, sencilla, elegante y moderna.
- Rectangular platform.
 - Double tier with different depth.
 - Includes bars for towels.
 - Antivandalism.
 - Fixed to wall by means of screws, concealed by support.
 - Functional, simple, elegant and modern.

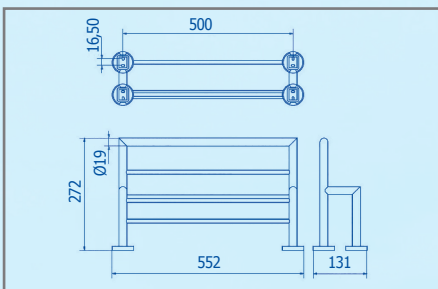

Dimensiones embalaje: (mm) 151
Packaging dimensions: 630 275

Características Técnicas Technical Characteristics		AW51300
Material Material		Latón / Brass
Acabado Finish		Cromado Brillo / Bright Chromed
Peso Neto Net Weight	(Kg)	1,070
Peso Bruto Gross Weight	(Kg)	1,455
Nº Barras Bars		5
Nº Niveles Levels		2
Nº Fijaciones Fixings		4

- FIJACIÓN: 8 tornillos + 8 tacos (incluidos). | FIXING: 8 screws + 8 wall plugs (included).
- EMBALAJE: Unitario. | PACKAGING: Single.
- LIMPIEZA: Bayeta húmeda. No usar productos químicos. | CLEANING: Damp cloth. Don't use chemicals.

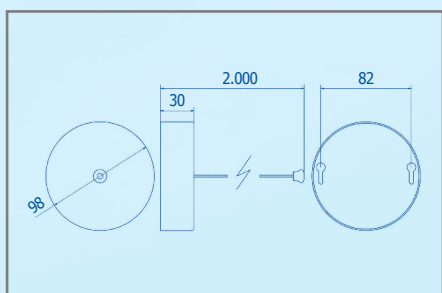

Dimensiones embalaje: (mm) 112
Packaging dimensions: 108 62

TENDEDERO EXTENSIBLE (2,5 M) PARED EXTENDABLE WALL CLOTHESLINE (2,5 M) AW61300

- Tendedero extensible de cable (2.5 m.)
- Resorte con recuperación automática.
- Fácil colocación.
- Antivandálico.
- Fijación a pared mediante tornillos ocultos.
- Funcional, sencillo, elegante y moderno.
- Extendable clothesline, 2.5 m cord.
- Automatic retractable cord mechanism.
- Easy to install.
- Antivandalism.
- Fixed to wall by means of screws, concealed fixing.
- Functional, simple, elegant and moder.

Características Técnicas Technical Characteristics	AW61300
Material Material	Inox / S. Steel
Acabado Finish	Brillo / Bright
Peso Neto Net Weight	(Kg) 0,230
Peso Bruto Gross Weight	(Kg) 0,275
Long. Máx. Max. Length	(m) 2,5

- FIJACIÓN: 2 tornillos + 2 tacos (incluidos). | FIXING: 2 screws + 2 wall plugs (included).
- EMBALAJE: Unitario. | PACKAGING: Single.
- LIMPIEZA: Bayeta húmeda. No usar productos químicos. | CLEANING: Damp cloth. Don't use chemicals.

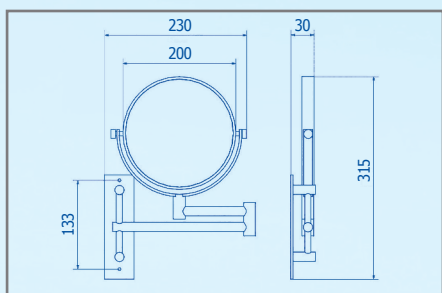

Dimensiones embalaje: (mm) 321
Packaging dimensions: 257 42

ESPEJO REGULABLE TELESCÓPICO TELESCOPIC ADJUSTABLE WALL MIRROR AW71300

- Espejo doble cara.
- Telescópico.
- Reversible con reflejo normal y aumento (x3).
- Antivandálico.
- Gira sobre 2 ejes: Horizontal y Vertical.
- Funcional, sencillo, elegante y moderno.
- Giratorio.
- Regulable en altura.
- Double sided mirror.
- Telescopic.
- Two sides: standard mirror and magnifying (x3).
- Antivandalism.
- Swivels in two axis: Horizontal and Vertical.
- Functional, simple, elegant and modern.
- Swivel.
- Adjustable to different heights.

Características Técnicas Technical Characteristics	AW71300
Material Material	Latón / Brass
Acabado Finish	Cromado Brillo / Bright Chromed
Peso Neto/Bruto Net/Gross Weight	(Kg) 0,835
Posición Corta Short Position	(mm) 250
Posición Larga Long Position	(mm) 1,060
Ø Espejo Ø Mirror	(mm) 200
Aumento Espejo Magnifying Mirror	x3

- FIJACIÓN: 2 tornillos + 2 tacos y dos embellecedores (incluidos). | FIXING: 2 screws + 2 wall plugs and two embellishers (included).
- EMBALAJE: Unitario. | PACKAGING: Single.
- LIMPIEZA: Bayeta húmeda. No usar productos químicos. | CLEANING: Damp cloth. Don't use chemicals.

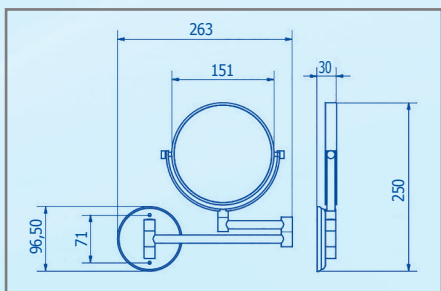

Dimensiones embalaje: (mm) 260
Packaging dimensions: 325 43

ESPEJO TELESCÓPICO TELESCOPIC WALL MIRROR AW72300

- Espejo doble cara.
- Telescópico.
- Espejo reversible con reflejo normal y aumento (x3).
- Antivandálico.
- Gira sobre 2 ejes: Horizontal y Vertical.
- Funcional, sencillo, elegante y moderno.
- Giratorio.
- Double sided mirror.
- Telescopic.
- Two sides : standard mirror and magnifying (x3).
- Antivandalism.
- Swivels in two axis : horizontal and vertical.
- Functional, simple, elegant and modern.
- Swivel.

Características Técnicas | Technical Characteristics

Características Técnicas Technical Characteristics		AW72300
Material Material		Latón / Brass
Acabado Finish		Cromado Brillo / Bright Chromed
Peso Neto NetWeight	(Kg)	0,615
Peso Bruto Gross Weight	(Kg)	0,830
Posición Corta Short Position	(mm)	250
Posición Larga Long Position	(mm)	375
Ø Espejo Ø Mirror	(mm)	150
Aumento Espejo Magnifying Mirror		x3

- FIJACIÓN: 2 tornillos + 2 tacos y dos embellecedores (incluidos). | FIXING: 2 screws + 2 wall plugs and two embellishers (included).
- EMBALAJE: Unitario. | PACKAGING: Single.
- LIMPIEZA: Bayeta húmeda. No usar productos químicos. | CLEANING: Damp cloth. Don't use chemicals.

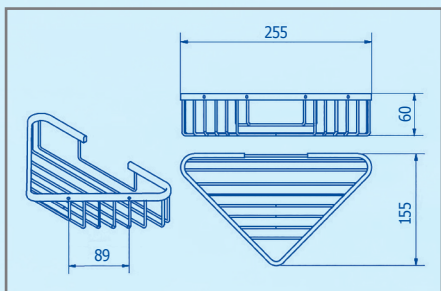
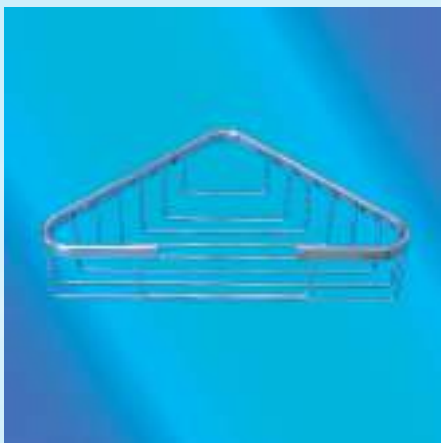

Dimensiones embalaje: (mm) 70
Packaging dimensions: 220 224

JABONERA TRIANGULAR DE REJILLA TRIANGLE SOAP DISH AW81300

- Jabonera esquina de rejilla.
- Triangular.
- Antivandálica.
- Borde superior reforzado y protegido.
- Mínimo espacio.
- Funcional, sencillo, elegante y moderno.
- Corner wire soap dish.
- Triangular.
- Antivandalism.
- Top edge protected and reinforced.
- Reduced dimensions.
- Functional, simple, elegant and modern.

Características Técnicas | Technical Characteristics

Características Técnicas Technical Characteristics		AW81300
Material Material		Latón / Brass
Acabado Finish		Cromado Brillo / Bright Chromed
Peso Neto Net Weight	(Kg)	0,380
Peso Bruto Gross Weight	(Kg)	0,500
Reborde Superior Upper Flange		X
Nº Barras Bars		8

- FIJACIÓN: 4 tornillos + 4 tacos y dos embellecedores (incluidos). | FIXING: 4 screws + 4 wall plugs and two embellishers (included).
- EMBALAJE: Unitario. | PACKAGING: Single.
- LIMPIEZA: Bayeta húmeda. No usar productos químicos. | CLEANING: Damp cloth. Don't use chemicals.

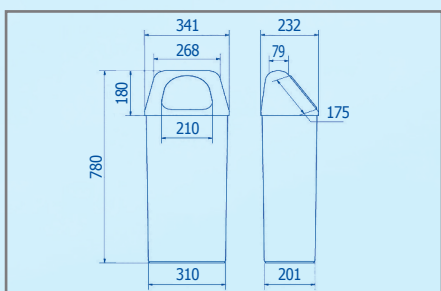

Dimensiones embalaje: (mm) $\begin{matrix} 625 \\ 248 \\ 350 \end{matrix}$
Packaging dimensions:

PAPELERA PLÁSTICO CON CABEZAL BATIENTE PLASTIC BINS WITH LID SWING

AL36000 - AL36050

"MEXICO"

- Fabricada en Polipropileno.
- Cabezal de ABS blanco desmontable y extraíble.
- Tapa batiente con resorte de retorno.
- Higiénica, ocultando interior y fácil limpieza.
- Puede colocarse en altura (AL36050) por soporte RL2010.
- Interior, Baños, Aseos, Dispensarios, Consultas, Clínicas, Hospitales, etc.

- Made of Polypropylene.
- Removable and detachable head, made of white ABS.
- Swing lid with return spring.
- Hygienic, waste concealed, easy to clean.
- Can be placed at a certain height (AL36050) by support (ref. RL2010).
- Indoors, Toilets, Bathrooms, Medical Clinics, Hospitals, etc.



AL36000

- Polipropileno Blanco
- Polypropylene White



AL36050

- Polipropileno Blanco
- Polypropylene White

Características Técnicas Technical Characteristics	AL36000	AL36050
Peso Neto/Bruto Net/Gross Weight (Kg)	2,470 / 2,890	3,065 / 3,485
Capacidad Volume (L)	40	40

- EMBALAJE: Unitario. | PACKAGING: Single.
- LIMPIEZA: Bayeta húmeda. No usar productos químicos. | CLEANING: Damp cloth. Don't use chemicals.

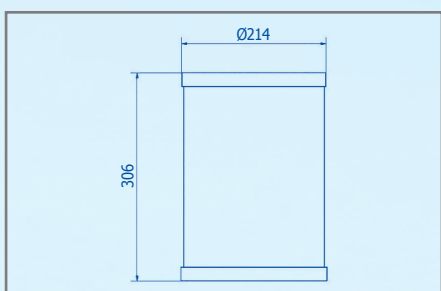

Dimensiones embalaje: (mm) $\begin{matrix} 325 \\ 225 \end{matrix}$
Packaging dimensions:

PAPELERA BAJA REDONDA CON AROS LOW ROUND BINS WITH RINGS

AL60000 - AL60001 - AL60002

"BERLIN"

- Papelera Universal.
- Inox. o chapa electrocincada.
- Espesor 1 mm.
- Protección base y boca mediante junquillo ABS.
- Cilíndrica, robusta y resistente.
- Interior, Oficinas, Despachos, etc.

- Universal bin.
- Made of eletro zinc coated sheet or Stainless Steel.
- 1 mm thick.
- ABS protection band on base and top.
- Cylindrical shape, sturdy, resistant.
- Indoors, Offices, Medical Clinics, etc.



AL60000



AL60001



AL60002

Características Técnicas Technical Characteristics	AL60000	AL60001	AL60002
Material Material	Chapa / S.Sheet	Inox / S.Steel	Chapa / S.Sheet
Acabado Finish	Poliéster / Polyester	Brillo / Bright	Poliéster / Polyester
Color Colour	A elegir / Choose	—	A elegir / Choose
Junquillo Sup./Inf. Upper/Lower Bands	ABS	ABS	ABS
Junquillo Acabado Finish Bands	Negro / Black	Cromado / Chromed	Cromado / Chromed
Capacidad Volume (L)	10	10	10
Peso Neto/Bruto Net/Gross Weight (Kg)	1,465 / 1,725	1,455 / 1,715	1,450 / 1,650

- EMBALAJE: Unitario. | PACKAGING: Single.
- LIMPIEZA: Bayeta húmeda. No usar productos químicos. | CLEANING: Damp cloth. Don't use chemicals.



PAPELERA ECO BÁSICA ECO PLASTIC BINS

AL60010E - AL60010N

"CARACAS"

- Fabricada en ABS.
- Color beige o negro.
- Ligeramente troncocónica.
- Apilables.
- Robusta y resistente.
- Fácil manipulación y limpieza.
- Interior, Oficinas, Despachos, etc.

- Made of ABS.
- Colours: beige or black.
- Slightly tapered shape.
- Stackable.
- Sturdy and resistant.
- Easy to handle and clean.
- Indoors, Offices, Medical Clinics, etc.

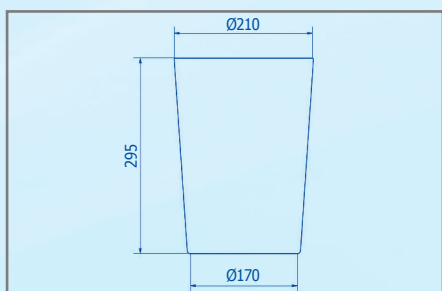

Dimensiones embalaje: (mm) 690
Packaging dimensions: 435 227



AL60010E

- ABS Beige
- ABS Beige



AL60010N

- ABS Negro
- ABS Black

Características Técnicas Technical Characteristics	AL60010E	AL60010N
Capacidad Volume (L)	10	10
Peso Neto Net Weight (Kg)	0,415	0,415
Peso Bruto (20 u.) Gross Weight (20 u.) (Kg)	9,100 (20 u.)	9,100 (20 u.)

- EMBALAJE: Unitario. | PACKAGING: Single.
- LIMPIEZA: Bayeta húmeda. No usar productos químicos. | CLEANING: Damp cloth. Don't use chemicals.

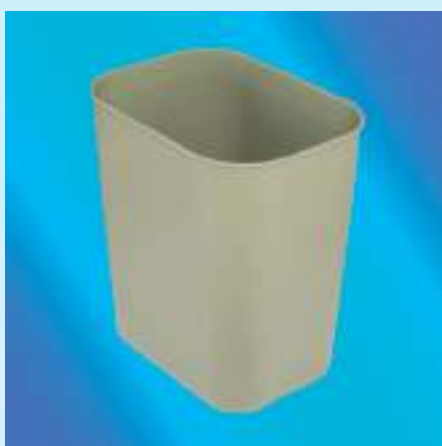

PAPELERA IGNÍFUGA FIREPROOF PLASTIC BINS

AL61008 - AL61015

"BOGOTÁ"

- Fabricada en material Plástico Ignífugo "V0".
- Ligeramente troncopiramidal.
- Apilables y de dos dimensiones.
- Robusta, resistente.
- Color beige.
- Interior, Oficinas, Despachos, etc.
- Uso Universal.

- Made of Fireproof Plastic material "V0".
- Slightly tapered.
- Stackable, two dimensions.
- Robust, resistant.
- Beige.
- Indoors, Premises, Offices, Medical Clinics, etc.
- Widespread use.

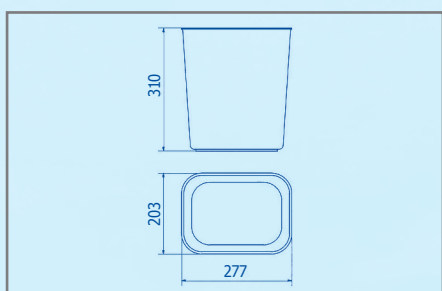

Dimensiones embalaje: (mm) 560
Packaging dimensions: 360 252



AL61008

- Plástico Ignífugo Beige
- Fireproof Plastic Beige



AL61015

- Plástico Ignífugo Beige
- Fireproof Plastic Beige

Características Técnicas Technical Characteristics	AL61008	AL61015
Capacidad Volume (L)	8	15
Peso Neto Net Weight (Kg)	0,365	0,565
Peso Bruto Gross Weight (Kg)	0,395	0,620

- EMBALAJE: Unitario. | PACKAGING: Single.
- LIMPIEZA: Bayeta húmeda. No usar productos químicos. | CLEANING: Damp cloth. Don't use chemicals.

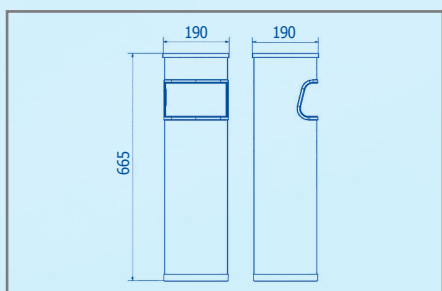

Dimensiones embalaje: (mm) 685
Packaging dimensions: 235 230

PAPELERA/CENICERO CUADRADA SQUARE BINS WITH ASHTRAY

AL70300 - AL70301

"DALLAS"

- Inox. o chapa electrocincada.
- Pintura de Poliéster.
- Espesor 1 mm.
- Protección ABS en base y boca.
- Cenicero Poliéster negro y extraíble fácilmente.
- Colores a elegir.
- Terrazas, Bares, Oficinas y Entradas de Establecimiento, etc.

- S. Steel or electro zinc coated Steel Sheet.
- Polyester paint.
- 1 mm thick.
- ABS protection on base and top.
- Black ashtray, Polyester paint, easy to remove.
- Several colours available.
- Terraces, Bars, Offices, Shops entrance, etc.



AL70300

- Chapa Poliéster
- Steel Sheet Polyester



AL70301

- Acero Inox Satinado
- Satin Stainless Steel

Características Técnicas Technical Characteristics	AL70300	AL70301
Capacidad Volume (L)	20	20
Peso Neto/Bruto Net/Gross Weight (Kg)	3,405 / 3,860	3,365 / 3,820
Cenicero: Material Ashtray: Material	Chapa / S.Sheet Poliéster / Polyester	Chapa / S.Sheet Poliéster / Polyester
Cenicero: Acabado Ashtray: Finish	Negro / Black	Negro / Black

- EMBALAJE: Unitario. | PACKAGING: Single.
- LIMPIEZA: Bayeta húmeda. No usar productos químicos. | CLEANING: Damp cloth. Don't use chemicals.

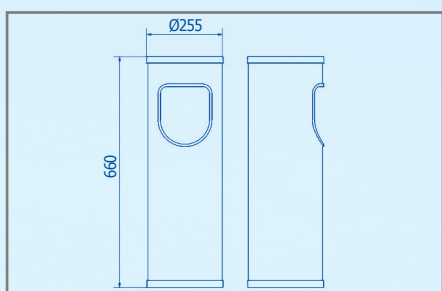

Dimensiones embalaje: (mm) 685
Packaging dimensions: 240 225

PAPELERA/CENICERO REDONDA ROUND BINS WITH ASHTRAY

AL70200 - AL70201

"VIENA"

- Inox. o chapa electrocincada.
- Pintura de Poliéster.
- Espesor 1 mm.
- Protección ABS en base y boca.
- Tapa Inox.
- Cenicero en Poliéster negro.
- Interiores, Oficinas, Despachos, etc.

- S. Steel or electro zinc coated Steel Sheet.
- Polyester paint.
- 1 mm thick.
- ABS protection on base and top.
- Stainless Steel cover.
- Black Polyester ashtray.
- Indoors, Offices, Medical Clinics, etc.



AL70200

- Chapa Poliéster
- Steel Sheet Polyester



AL70201

- Acero Inox Satinado
- Satin Stainless Steel

Características Técnicas Technical Characteristics	AL70200	AL70201
Tapa Superior Top Cover	Inox / S.Steel	Inox / S.Steel
Capacidad Volume (L)	25	25
Peso Neto/Bruto Net/Gross Weight (Kg)	3,285 / 3,740	3,285 / 3,740
Cenicero: Material Ashtray: Material	Chapa / S.Sheet Poliéster / Polyester	Chapa / S.Sheet Poliéster / Polyester
Cenicero: Acabado Ashtray: Finish	Negro / Black	Negro / Black

- EMBALAJE: Unitario. | PACKAGING: Single.
- LIMPIEZA: Bayeta húmeda. No usar productos químicos. | CLEANING: Damp cloth. Don't use chemicals.

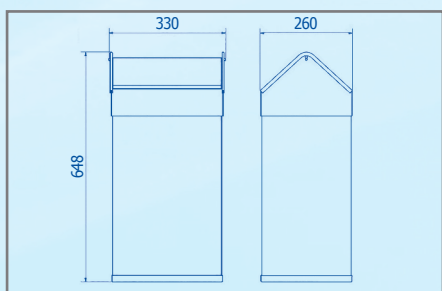

Dimensiones embalaje: (mm) 680
Packaging dimensions: 340 265

PAPELERAS TAPA BASCULANTE SWIVEL LID BINS

AL70500 - AL70501

"DAYTON"

- Inox. o chapa electrocincada.
- Espesor 0,8/1 mm.
- Capacidad 40 L.
- Pintura de Poliéster.
- Colores a elegir.
- Protección en base y cabezal.
- Cabezal desmontable con balancín.
- Interiores, Oficinas, Centros Comerciales, Grandes Instalaciones.

- S.Steel or eletro zinc coated Steel Sheet.
- 0.8/1 mm thick.
- 40 L capacity.
- Polyester paint.
- Several colours available.
- ABS protection on base and top.
- Removable head with swing lid.
- Indoors, offices, department stores, shopping centres.



AL70500

- Chapa Poliéster
- Steel Sheet Polyester



AL70501

- Acero Inox Satinado
- Satin Stainless Steel

Características Técnicas Technical Characteristics	AL70500	AL70501
Capacidad Volume (L)	40	40
Peso Neto/Bruto Net/Gross Weight (Kg)	6,155 / 6,640	5,700 / 6,145

- EMBALAJE: Unitario. | PACKAGING: Single.
- LIMPIEZA: Bayeta húmeda. No usar productos químicos. | CLEANING: Damp cloth. Don't use chemicals.

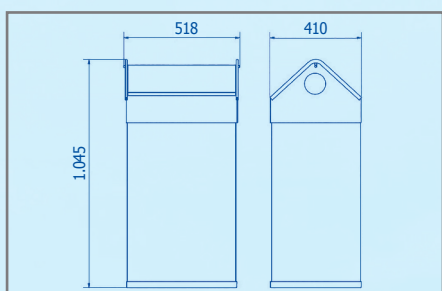

Dimensiones embalaje: (mm) 870
Packaging dimensions: 515 465

PAPELERA TAPA BASCULANTE CON CENICERO SWIVEL LID BIN WITH ASHTRAY

AL71700

"MIAMI"

- Chapa electrocincada.
- Pintada en Poliéster.
- Espesor 1 mm.
- Colores a elegir.
- Capacidad 180 L.
- Junquillo protección ABS en base y cabezal
- Cabezal desmontable y balancín basculante doble sentido.
- Interior, Exterior, Grandes Superficies, Centro Comerciales, Horeca, Industria, Taller, Oficinas, etc.

- Electro zinc coated Steel Sheet.
- Polyester paint.
- 1 mm thick.
- Several colours to choose.
- 180 L capacity.
- ABS protection bands on base and top.
- Removable head, swing lid, accessed from both sides.
- Indoors, Outdoors, Department Stores, Shopping Centers, Horeca, Industry, Ateliers, Offices, etc.

Características Técnicas Technical Characteristics	AL71700
Material Material	Chapa / Steel Sheet
Acabado Finish	Poliéster / Polyester
Color Colour	A elegir / Choose
Capacidad Volume (L)	180
Peso Neto/Bruto Net/Gross Weight (Kg)	19,100 / 21,150
Espesor Thickness (mm)	1

- EMBALAJE: Unitario. | PACKAGING: Single.
- LIMPIEZA: Bayeta húmeda. No usar productos químicos. | CLEANING: Damp cloth. Don't use chemicals.

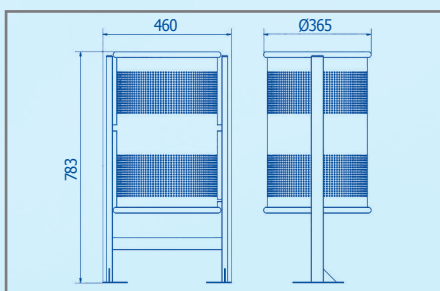

Dimensiones embalaje: (mm) 865
Packaging dimensions: 450 420

- EMBALAJE: Unitario. | PACKAGING: Single.
- LIMPIEZA: Bayeta húmeda. No usar productos químicos. | CLEANING: Damp cloth. Don't use chemicals.

PAPELERA CIRCULAR DOBLE PIE ROUND BIN DOUBLE LEG

AL71200 - AL71300

"ROMA"

- Chapa electrocincada.
- Pintada en Poliéster.
- Espesor 1 mm.
- Franja central compacta y superior/ inferior perforada.
- Cerradura con llave.
- Antivandálica.
- Fijado a suelo con doble pie y barra de refuerzo.
- Basculante para vaciado.
- Exterior, Interior, Parques, Jardines, Urbanizaciones, Piscinas, etc.
- Electro zinc coated Steel Sheet.
- Polyester paint.
- 1 mm thick.
- Middle stripe compact, upper and lower stripes perforated.
- Key lock.
- Antivandalism.
- Fixed to floor by its two feet, reinforcement bar.
- Reclining for easy emptying.
- Outdoors, Parks, Gardens, Urbanizations, Swimming Pool, etc.



AL71200

- Chapa Poliéster
- Steel Sheet Polyester



AL71300

- Chapa Poliéster
- Steel Sheet Polyester

Características Técnicas | Technical Characteristics

	AL71200	AL71300
Color Colour	A elegir / Choose	A elegir / Choose
Capacidad Volume	60 (L)	90
Peso Neto/Bruto Net/Gross Weight	7,020 / 8,220 (Kg)	9,000 / 10,500

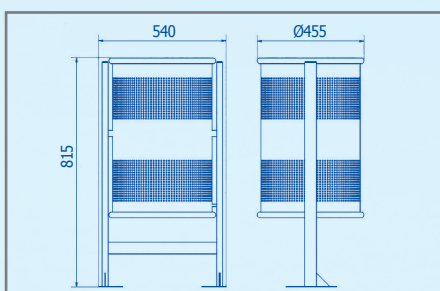

Dimensiones embalaje: (mm) 880
Packaging dimensions: 515 515

- EMBALAJE: Unitario. | PACKAGING: Single.
- LIMPIEZA: Bayeta húmeda. No usar productos químicos. | CLEANING: Damp cloth. Don't use chemicals.

PAPELERA CIRCULAR ANTICORROSIÓN DOBLE PIE ROUND ANTICORROSION BIN DOUBLE LEG

AL71200ES - AL71300ES

"PARIS"

- Chapa electrocincada.
- Doble tratamiento y pintura anticorrosiva.
- Pintura y barniz de Poliester.
- Lacadas con polvo de material sintético. Espesor 1 mm.
- Acabado metálico brillo.
- Cerradura con llave. Antivandálica.
- Fijadas a suelo con doble pie y barra de refuerzo.
- Basculante para vaciado.
- Exteriores, Parques, Jardines, Piscinas, Urbanizaciones, etc.
- Electro zinc coated Steel Sheet.
- Double treatment, anti-corrosion paint
- Paint and varnish with Polyester.
- Varnished with synthetic material powder. 1 mm thick.
- Bright metallic finish.
- Key lock. Antivandalism.
- Fixed to floor by means of double leg, reinforcement bar.
- Reclining for easy emptying.
- Outdoors, Parks, Gardens, Swimming Pools, Resorts, etc.



AL71200ES

- Chapa Poliéster
- Steel Sheet Polyester



AL71300ES

- Chapa Poliéster
- Steel Sheet Polyester

Características Técnicas | Technical Characteristics

	AL71200ES	AL71300ES
Color Colour	Plata / Silver	Plata / Silver
Capacidad Volume	60 (L)	90
Peso Neto/Bruto Net/Gross Weight	7,020 / 8,220 (Kg)	9,000 / 10,500

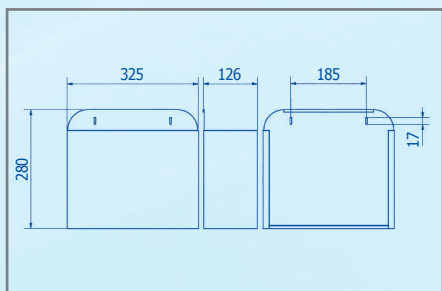

Dimensiones embalaje: (mm) 310
Packaging dimensions: 335 135

- EMBALAJE: Unitario. | PACKAGING: Single.
- LIMPIEZA: Bayeta húmeda. No usar productos químicos. | CLEANING: Damp cloth. Don't use chemicals.

PAPELERAS MURAL WALL BINS

AL71600 - AL71601 - AL71621 - AL716251 "ORLANDO"

- Inox. o chapa electrocincada.
- Extraíbles de la pared.
- Pintadas en Poliéster. Colores a elegir.
- Capacidad 10/20/25 L.
- Sobrealzado de la parte posterior para protección (AL71600/71601).
- Exterior e Interior, Horeca, Fábricas, Talleres, Colectividades, Colegios, etc.

- Inox or electro zinc coated Steel Sheet.
- Detachable from wall.
- Polyester paint. Colours to choose.
- 10/20/25 L capacity.
- Rear part stands out for protection (AL71600/71601).
- Indoors and Outdoors, Horeca, Industry, Ateliers, Collectivities, Schools, etc.



AL71600



AL71601



AL71621



AL716251

Características Técnicas Technical Characteristics	AL71600	AL71601	AL71621	AL716251
Material Material	Chapa / S.Sheet	Inox / S.Steel	Inox / S.Steel	Inox / S.Steel
Acabado Finish	Poliéster / Polyester	Satinado / Satin	Satinado / Satin	Satinado / Satin
Color Colour	A elegir / Choose	—	—	—
Capacidad Volume (L)	10	10	20	25
Peso Neto/Bruto Net/Gross Weight (Kg)	1,835 / 2,010	1,720 / 1,905	2,855 / 3,075	3,568 / 3,843
Espesor Thickness (mm)	1	0,8	0,8	0,8

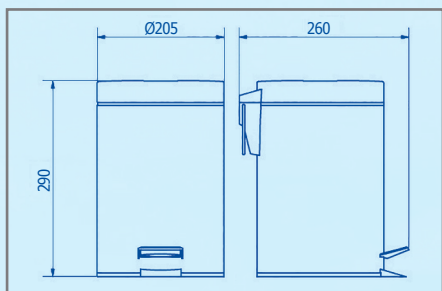

Dimensiones embalaje: (mm) 300
Packaging dimensions: 222 250

- EMBALAJE: Unitario. | PACKAGING: Single.
- LIMPIEZA: Bayeta húmeda. No usar productos químicos. | CLEANING: Damp cloth. Don't use chemicals.

PAPELERA MÉTALICA CON PEDAL METAL PEDAL BINS

AL72003C - AL72005C - AL72012C - AL72020C "LYON"

- Chapa Acero Cromado brillo.
- Tapa abatible.
- Apertura y cierre con pedal.
- Cubo interior Polipropileno negro.
- Cubo extraíble con asas.
- WC, Lavabos, Baños, Oficinas, etc.

- Chrome Plated Steel Sheet.
- Reclining lid.
- Pedal for opening and closing.
- Inner bucket, made of black propylene.
- Removable inner bucket with handle.
- WC, Toilets, Bathrooms, Offices, etc.



AL72003C



AL72005C



AL72012C



AL72020C

Características Técnicas Technical Characteristics	AL72003C	AL72005C	AL72012C	AL72020C
Material Material	Acero / S.Sheet	Acero / S.Sheet	Acero / S.Sheet	Acero / S.Sheet
Acabado Finish	Cromado / Chromed	Cromado / Chromed	Cromado / Chromed	Cromado / Chromed
Color Colour	Brillo / Bright	Brillo / Bright	Brillo / Bright	Brillo / Bright
Capacidad Volume (L)	3	5	12	20
Peso Neto/Bruto Net/Gross Weight (Kg)	0,735 / 0,965	1,100 / 1,450	1,810 / 2,275	2,470 / 3,025
Cubo Interior Inner Bucket	X	X	X	X
Cubo Extraíble Removable Bucket	X	X	X	X

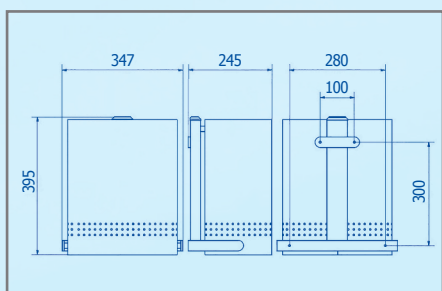

Dimensiones embalaje: (mm) 525
Packaging dimensions: 370 262

PAPELERA MURAL ABATIBLE RECLINING BIN, WALL MOUNTED

AL71900

"CHICAGO"

- Chapa electrocincada.
- Pintada en Poliéster.
- Espesor 1 mm.
- Color a elegir.
- Antivandálica.
- Abatible.
- Fijada a pared mediante bastidor atornillado a pared.
- Con cerradura.
- Parte inferior perforado para visualizar y pictograma.
- Interior, Exterior, Parking, Garajes, Industria, Cajeros, Centros Comerciales, Colectividades, etc.
- Electro zinc coated Steel Sheet.
- Polyester paint.
- 1 mm thick.
- Several colours to choose.
- Antivandalism.
- Reclining.
- Fixed by means of a frame screwed to wall.
- Key lock.
- Bottom stripe perforated to view content, pictogram.
- Indoors, Outdoors, Parking, Garages, Industry, Cash Dispensers, Shopping Centres, Collectivities, etc.

Características Técnicas | Technical Characteristics

AL71900

Material Material	Chapa / Steel Sheet
Acabado Finish	Poliéster / Polyester
Color Colour	A elegir / Choose
Capacidad Volume	(L) 30
Peso Neto/Bruto Net/Gross Weight	(Kg) 5,170 / 5,630

- EMBALAJE: Unitario. | PACKAGING: Single.
- LIMPIEZA: Bayeta húmeda. No usar productos químicos. | CLEANING: Damp cloth. Don't use chemicals.

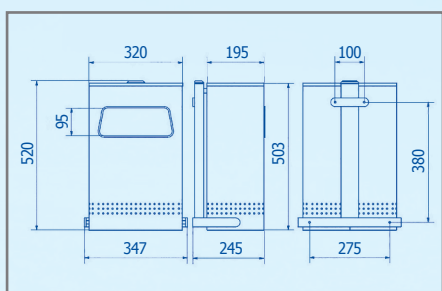

Dimensiones embalaje: (mm) 530
Packaging dimensions: 360 270

PAPELERA/CENICERO ABATIBLE MURAL RECLINING BIN ASHTRAY, WALL MOUNTED

AL72700

"DETROIT"

- Chapa electrocincada.
- Pintada en Poliéster.
- Colores a elegir.
- Espesor 1 mm.
- Cenicero superior color negro, extraíble.
- Papelera inferior perforada y amplia boca con junquillo ABS.
- Abatible con estructura fijada a pared.
- Antivandálica.
- Con llave.
- Capacidad 40 L.
- Exterior, Parking, Cajeros, Garajes, etc.
- Electro zinc coated Steel Sheet.
- Polyester paint.
- Several colours to choose.
- 1 mm thick.
- Removable black ashtray on top.
- Bin perforated at the bottom, large opening with ABS protection band.
- Structure fixed to wall, reclining bin.
- Antivandalism.
- Key lock.
- 40 L capacity.
- Outdoors, Parking, Cash Dispensers, Garages, etc.

Características Técnicas | Technical Characteristics

AL72700

Material Material	Chapa / Steel Sheet
Acabado Finish	Poliéster / Polyester
Color Colour	A elegir / Choose
Capacidad Volume	(L) 40
Peso Neto/Bruto Net/Gross Weight	(Kg) 6,515 / 6,910

- FIJACIÓN: A pared mediante 4 tornillos + 4 tacos (incluidos). | FIXING: To wall with 4 screws + 4 wall plugs (included).
- EMBALAJE: Unitario. | PACKAGING: Single.
- LIMPIEZA: Bayeta húmeda. No usar productos químicos. | CLEANING: Damp cloth. Don't use chemicals.

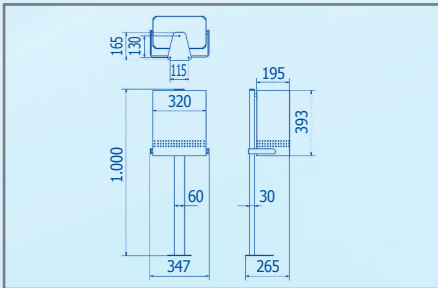

Dimensiones embalaje: (mm) 1.025
 Packaging dimensions: 368 270

PAPELERA SUELO ABATIBLE POST MOUNT RECLINING BIN

AL71910

"ATLANTA"

- Chapa electrocincada.
- Pintada en Poliéster.
- Espesor 1 mm.
- Colores a elegir.
- Capacidad 30 L.
- Antivandálica.
- Abatible.
- Cerradura con llave.
- Fijada a suelo por bastidor de pie.
- Parte inferior perforada para visualizar y pictograma.
- Interior, Exterior, Parking, Garajes, Industria, Cajeros, Centros Comerciales, Colectividades.

- Electro zinc coated Steel Sheet.
- Polyester paint.
- 1 mm thick.
- Several colours to choose.
- 30 L capacity.
- Antivandalism.
- Reclining.
- Key lock.
- Floor mounted by means of a post.
- Bottom stripe perforated to view inside and pictogram.
- Indoors, Outdoors, Parking, Garages, Industry, Cash Dispensers, Shopping Centers, Collectivities, etc.

Características Técnicas | Technical Characteristics

		AL71910
Material Material		Chapa / Steel Sheet
Acabado Finish		Poliéster / Polyester
Color Colour		A elegir / Choose
Capacidad Volume	(L)	30
Peso Neto/Bruto Net/Gross Weight	(Kg)	6,245 / 7,120

- EMBALAJE: Unitario. | PACKAGING: Single.
- LIMPIEZA: Bayeta húmeda. No usar productos químicos. | CLEANING: Damp cloth. Don't use chemicals.

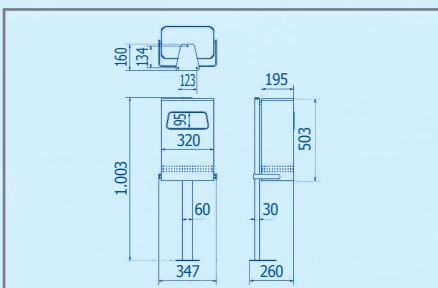

Dimensiones embalaje: (mm) 1.025
 Packaging dimensions: 365 265

PAPELERA/CENICERO ABATIBLE CON PIE RECLINING BIN ASHTRAY

AL72710

"TUCSON"

- Chapa electrocincada.
- Pintada en Poliéster.
- Colores a elegir.
- Espesor 1 mm.
- Capacidad 40 L.
- Abatible con estructura fijada a suelo con llave.
- Antivandálica.
- Cenicero superior bandeja color negro, extraíble.
- Papelera inferior perforada.
- Amplia boca con junquillo ABS.
- Exterior, Parking, Garajes, Cajeros, Industria, Talleres, etc.

- Electro zinc coated Steel Sheet.
- Polyester paint.
- Several colours to choose.
- 1 mm thick.
- 40 L capacity.
- Structure fixed to floor with key, reclining bin.
- Antivandalism.
- Removable black ashtray on top.
- Bin perforated at bottom.
- Large opening with ABS protection band.
- Outdoors, Parking, Garages, Cash Dispensers, Industry, Ateliers, etc.

Características Técnicas | Technical Characteristics

		AL72710
Material Material		Chapa / Steel Sheet
Acabado Finish		Poliéster / Polyester
Color Colour		A elegir / Choose
Capacidad Volume	(L)	40
Peso Neto/Bruto Net/Gross Weight	(Kg)	7,765 / 8,640

- EMBALAJE: Unitario. | PACKAGING: Single.
- LIMPIEZA: Bayeta húmeda. No usar productos químicos. | CLEANING: Damp cloth. Don't use chemicals.

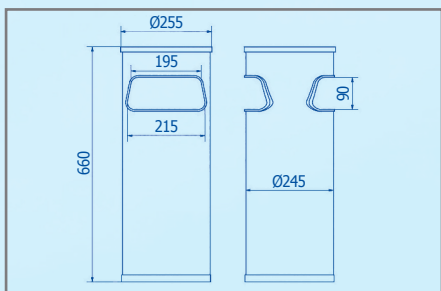

Dimensiones embalaje: (mm) $\begin{matrix} 690 \\ 270 \end{matrix}$
Packaging dimensions: $\begin{matrix} 690 \\ 270 \end{matrix}$

- EMBALAJE: Unitario. | PACKAGING: Single.
- LIMPIEZA: Bayeta húmeda. No usar productos químicos. | CLEANING: Damp cloth. Don't use chemicals.

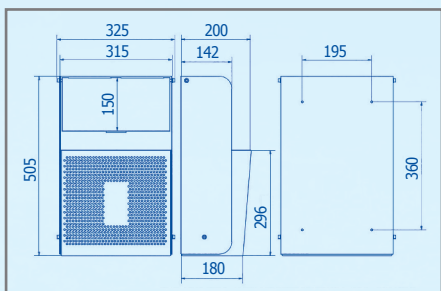

Dimensiones embalaje: (mm) $\begin{matrix} 530 \\ 365 \end{matrix}$
Packaging dimensions: $\begin{matrix} 530 \\ 365 \end{matrix}$

PAPELERA/CENICERO DOBLE ABERTURA ROUND ASHTRAY AND LITTER BIN, TWO OPENINGS AL72200 - AL72201 "BRUSELAS"

- Inox. o chapa electrocincada.
- Pintada en Poliéster (AL72200).
- Colores a elegir.
- Cenicero en Poliéster negro desmontable.
- Capacidad 30 L con abertura.
- Tapa cenicero en acero Inox. y junquillos ABS en base y bocas.
- Cenicero desmontable.
- Interior, Oficinas, Despachos, etc.



AL72200

- Chapa Poliéster
- Steel Sheet Polyester

- S.Steel or electro zinc coated Steel Sheet.
- Polyester paint (AL72200).
- Several colours to choose.
- Removable ashtray, painted with black Polyester.
- 30 L capacity, with opening.
- Ashtray lid made of S. Steel, ABS protection bands on base and opening.
- Removable ashtray.
- Indoors, Offices, Medical Clinics, etc.



AL72201

- Acero Inox Satinado
- Satin Stainless Steel

Características Técnicas Technical Characteristics	AL72200	AL72201
Color Colour	A elegir / Choose	—
Peso Neto/Bruto Net/Gross Weight (Kg)	3,705 / 4,280	3,910 / 4,465
Capacidad Volume (L)	30	30
Espesor Thickness (mm)	1	0,8

PAPELERA/CENICERO MURAL ABATIBLE RECLINING ASHTRAY AND LITTER BIN, WALL MOUNTED AL72500 "PORTLAND"

- Chapa electrocincada.
- Pintada Poliéster.
- Espesor 1 mm.
- Colores a elegir.
- Capacidad 20 L.
- Mixta. Superior: Cenicero. Inferior: Papelera perforada.
- Antivandálica, fijada a pared por tornillos.
- Abatible para vaciado y con pictogramas (2) indicativos.
- Exterior, Parking, Cajeros, Garajes, Industria, etc.

- Electro zinc coated Steel Sheet.
- Polyester paint.
- 1.0 mm thick.
- Several colours to choose.
- 20 L capacity.
- Double function: ashtray on top, perforated bin at the bottom.
- Antivandalism system, fixed to wall by means of screws.
- Reclining for easy emptying, includes 2 pictograms.
- Outdoors, Car Parks, Cash Dispensers, Garages, Industry, etc.

Características Técnicas Technical Characteristics	AL72500
Material Material	Chapa / Steel Sheet
Acabado Finish	Poliéster / Polyester
Color Colour	A elegir / Choose
Capacidad Volume (L)	20
Peso Neto/Bruto Net/Gross Weight (Kg)	5,915 / 6,335

- FIJACIÓN: A pared mediante 4 tornillos + 4 tacos (incluidos). | FIXING: To wall with 4 screws + 4 wall plugs (included).
- EMBALAJE: Unitario. | PACKAGING: Single.
- LIMPIEZA: Bayeta húmeda. No usar productos químicos. | CLEANING: Damp cloth. Don't use chemicals.

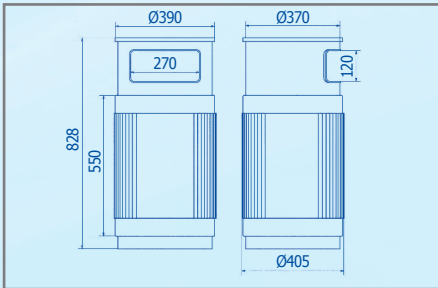

Dimensiones embalaje: (mm) 865
Packaging dimensions: 415 455

- EMBALAJE: Unitario. | PACKAGING: Single.
- LIMPIEZA: Bayeta húmeda. No usar productos químicos. | CLEANING: Damp cloth. Don't use chemicals.

PAPELERA/CENICERO CILÍNDRICA CON POLIURETANO ROUND ASHTRAY AND LITTER WITH POLYURETHANE AL73101 "BERNA"

- Inox. satinado.
- Espesor 0,8 mm.
- Forrada exteriormente con protección de Poliuretano.
- Cenicero superior pintado en Poliéster negro.
- Tapa acero Inox.
- Parte superior extraíble y doble abertura lateral.
- Junquillo ABS negro en base y boca, para protección.
- Cubo interior, metálico, extraíble.
- Capacidad 50 L.
- Exterior, Interior, Parking, Garajes, Grades Superficies, Oficinas, Despachos, Hospitales, Clínicas, Recreativos, Polideportivos.

- Stainless Steel, satin finish.
- 0.8 mm thick.
- Externally covered with black Polyurethane protection.
- Upper ashtray painted with black Polyester.
- Stainless Steel lid.
- Removable cover, double opening on both sides.
- Black ABS protection bands on base and opening.
- Removable metallic inner bucket.
- 50 L capacity.
- Indoors, Outdoors, Parking, Garages, Department Stores, Offices, Hospitals, Medical Clinics, Sport Centers.

Características Técnicas | Technical Characteristics

		AL73101
Material Material		Inox / Stainless Steel
Acabado Finish		Satinado / Satin
Protección Protection		Poliuretano / Polyurethane
Capacidad Volume	(L)	50
Peso Neto/Bruto Net/Gross Weight	(Kg)	16,500 / 17,800

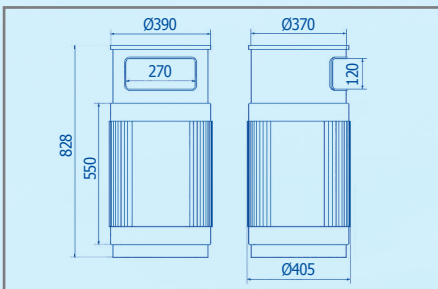

Dimensiones embalaje: (mm) 865
Packaging dimensions: 415 455

PAPELERA CILÍNDRICA CON POLIURETANO ROUND BIN WITH POLYURETHANE AL73111 "GINEBRA"

- Inox.
- Espesor 0,8 mm.
- Forrada exteriormente de Poliuretano para protección.
- Tapa superior desmontable y extraíble.
- Abertura lateral amplia.
- Cubo interior metálico extraíble.
- Capacidad 50 L.
- Junquillo ABS negro en base y boca como protección.
- Exterior, Interior, Parking, Garajes, Grandes Superficies, Centros Comerciales, Oficinas, Hospitales, etc.

- Stainless Steel satin finish.
- 0.8 mm thick.
- Externally covered with Polyurethane protection.
- Top lid detachable and removable.
- Large side opening.
- Removable metallic inner bucket.
- 50 L capacity.
- Black ABS protection bands on base and opening.
- Outdoors, Indoors, Parking, Garages, Department Stores, Offices, Hospitals, Clinics, Retirement Homes, etc.

Características Técnicas | Technical Characteristics

		AL73111
Material Material		Inox / Stainless Steel
Acabado Finish		Satinado / Satin
Protección Protection		Poliuretano / Polyurethane
Capacidad Volume	(L)	50
Peso Neto/Bruto Net/Gross Weight	(Kg)	15,500 / 16,800

- EMBALAJE: Unitario. | PACKAGING: Single.
- LIMPIEZA: Bayeta húmeda. No usar productos químicos. | CLEANING: Damp cloth. Don't use chemicals.

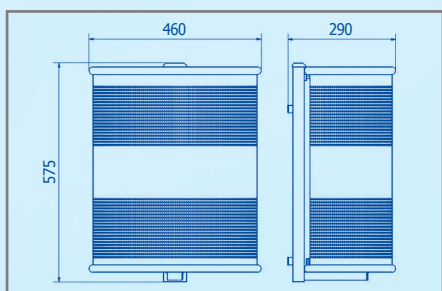
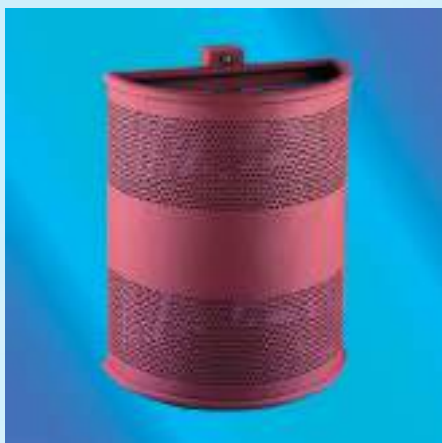

Dimensiones embalaje: (mm) 600
Packaging dimensions: 480 295

PAPELERA SEMICIRCULAR MURAL ABATIBLE WALL MOUNTED HALF ROUND BIN, RECLINING AL81200 "TOKIO"

- Chapa electrocincada.
- Pintada en Poliéster.
- Espesor 1 mm.
- Colores a elegir.
- Abatible fijada a pared por bastidor.
- Capacidad 40 L.
- Semicircular.
- Parte central compacta y superior e inferior perforada.
- Con cerradura y llave.
- Antivandálica.
- Exterior, Interior, Parques, Jardines, Urbano, etc.
- Electro zinc coated Steel Sheet.
- Polyester paint.
- 1 mm thick.
- Several colours to choose.
- Fixed to wall and reclining.
- 40 L capacity.
- Half round shape.
- Stripe compact, upper and lower perforated.
- With key lock.
- Antivandalism.
- Outdoors, Indoors, Parks, Gardens, Urban Environment, etc.

Características Técnicas | Technical Characteristics

Características Técnicas Technical Characteristics		AL81200
Material Material		Chapa / Steel Sheet
Acabado Finish		Poliéster / Polyester
Color Colour		A elegir / Choose
Capacidad Volume	(L)	40
Peso Neto/Bruto Net/Gross Weight	(Kg)	6,350 / 8,150

- EMBALAJE: Unitario. | PACKAGING: Single.
- LIMPIEZA: Bayeta húmeda. No usar productos químicos. | CLEANING: Damp cloth. Don't use chemicals.

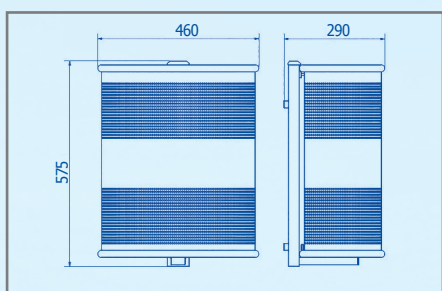

Dimensiones embalaje: (mm) 600
Packaging dimensions: 480 295

PAPELERA SEMICIRCULAR ANTICORROSIVA MURAL ABATIBLE WALL MOUNTED HALF ROUND ANTICORROSION BIN, RECLINING AL81200ES "KOBE"

- Chapa electrocincada.
- Doble tratamiento y pintura anticorrosiva.
- Pintura y barniz de Poliéster.
- Lacada con polvo de material sintético.
- Acabado metálico brillo.
- Espesor 1 mm.
- Abatible, fijada a pared por bastidor.
- Capacidad 40 L.
- Franja central compacta y superior e inferior perforadas.
- Cerradura con llave.
- Antivandálica.
- Ambientes agresivos, especialmente costeros.
- Exteriores, Parques, Jardines, Piscinas, Urbanizaciones, etc.
- Electro zinc coated Steel Sheet.
- Double treatment and anti-corrosion paint.
- Polyester varnish and paint.
- Varnished with synthetic material powder.
- Bright metallic finish.
- 1 mm thick.
- Reclining, fixed to wall.
- Capacity: 40 L.
- Middle stripe compact, upper and lower stripes perforated.
- Key lock.
- Antivandalism.
- Aggressive environments, especially on the coast.
- Outdoors, Parks, Gardens, Swimming Pools, Resorts, etc.

Características Técnicas | Technical Characteristics

Características Técnicas Technical Characteristics		AL81200ES
Material Material		Chapa / Steel Sheet
Acabado Finish		Poliéster / Polyester
Color Colour		Plata / Silver
Capacidad Volume	(L)	40
Peso Neto/Bruto Net/Gross Weight	(Kg)	6,350 / 8,150

- EMBALAJE: Unitario. | PACKAGING: Single.
- LIMPIEZA: Bayeta húmeda. No usar productos químicos. | CLEANING: Damp cloth. Don't use chemicals.

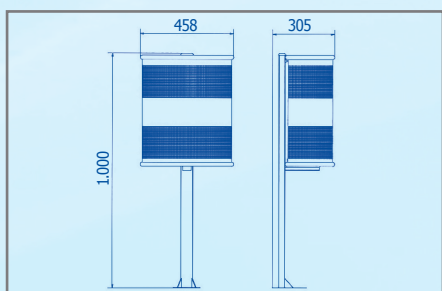

Dimensiones embalaje: (mm) 1.015
Packaging dimensions: 475 300

PAPELERA SEMICIRCULAR FIJADA A SUELO POST MOUNTED HALF ROUND BIN RECLINING AL81400 "DELHI"

- Chapa electrocincada.
- Pintada en Poliéster.
- Colores a elegir.
- Espesor 1 mm.
- Abatible fijada a suelo por bastidor.
- Semicircular.
- Antivandálica.
- Cuerpo central compacto y superior e inferior perforado.
- Capacidad 40 L.
- Con cerradura y llave.
- Exterior, Interior, Parques, Jardines, Urbanas, etc.
- Electro zinc coated Steel Sheet.
- Polyester paint.
- Several colours to choose.
- 1 mm thick.
- Reclining bin fixed to floor by means of a post.
- Half round shape.
- Antivandalism.
- Middle stripe compact, upper and lower perforated.
- Capacity: 40 L.
- With key lock.
- Outdoors, Indoors, Parks, Gardens, Urban Environment, etc.

Características Técnicas | Technical Characteristics

AL81400

Material Material	Chapa / Steel Sheet
Acabado Finish	Poliéster / Polyester
Color Colour	A elegir / Choose
Capacidad Volume	(L) 40
Peso Neto/Bruto Net/Gross Weight	(Kg) 8,920 / 10,140

- FIJACIÓN: A suelo mediante 3 tornillos + 3 tacos (incluidos). 1 solo pie. | FIXING: To floor with 3 screws + 3 wall plugs (included). 1 foot only.
- EMBALAJE: Unitario. | PACKAGING: Single.
- LIMPIEZA: Bayeta húmeda. No usar productos químicos. | CLEANING: Damp cloth. Don't use chemicals.

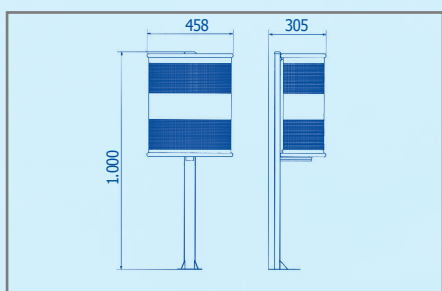

Dimensiones embalaje: (mm) 1.015
Packaging dimensions: 475 300

PAPELERA SEMICIRCULAR ANTICORROSIVA FIJADA AL SUELO POST MOUNTED HALF ROUND ANTICORROSION BIN RECLINING AL81400ES "BALI"

- Chapa electrocincada.
- Doble tratamiento y pintura anticorrosiva.
- Pintura y barniz de Poliéster.
- Lacada con polvo de material sintético.
- Acabado metálico brillo.
- Franja central compacta y superior e inferior perforadas.
- Abatible, fijada a suelo por bastidor.
- Semicircular. Espesor 1 mm.
- Antivandálica. Cerradura con llave.
- Capacidad 40 L.
- Ambientes agresivos, especialmente costeros.
- Exteriores, Parques, Jardines, Urbanas, etc.
- Electro zinc coated Steel Sheet.
- Double treatment, anti-corrosion paint.
- Polyester paint and varnish.
- Varnished with synthetic material powder.
- Bright metallic finish.
- Middle stripe compact, upper and lower perforated.
- Reclining, fixed to floor by means of a frame.
- Half round shape. 1 mm thick.
- Antivandalism. Key lock.
- Capacity: 40 L.
- Aggressive environments, especially on the coast.
- Outdoors, Parks, Gardens, Urban Environments, etc.

Características Técnicas | Technical Characteristics

AL81400ES

Material Material	Chapa / Steel Sheet
Acabado Finish	Poliéster / Polyester
Color Colour	Plata / Silver
Capacidad Volume	(L) 40
Peso Neto/Bruto Net/Gross Weight	(Kg) 8,920 / 10,140

- EMBALAJE: Unitario. | PACKAGING: Single.
- LIMPIEZA: Bayeta húmeda. No usar productos químicos. | CLEANING: Damp cloth. Don't use chemicals.

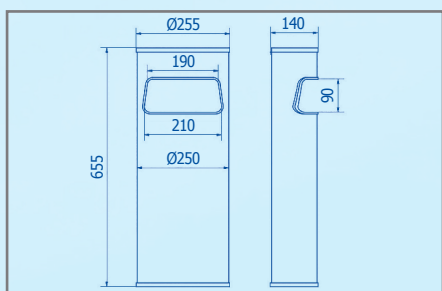

Dimensiones embalaje: (mm) 685
Packaging dimensions: 240 230

- EMBALAJE: Unitario. | PACKAGING: Single.
- LIMPIEZA: Bayeta húmeda. No usar productos químicos. | CLEANING: Damp cloth. Don't use chemicals.

PAPELERA/CENICERO SEMICIRCULAR ASHTRAY AND LITTER HALF ROUND "PEKIN"

AL82200 - AL82201

- Inox. o chapa electrocincada.
- Pintadas en Poliéster.
- Colores a elegir.
- Espesor 0,8/1 mm. Capacidad 15 L.
- Cenicero superior pintado Poliéster negro y extraíble.
- Abertura frontal para papelera.
- Fácil vaciado y limpieza.
- Junquillo protector en ABS negro en base y boca.
- Interior, Oficina, Despachos, Colegios, Consultas, Recepciones, Colectivos, etc.
- S.Steel or electro zinc coated Steel Sheet.
- Polyester paint.
- Different colours to choose.
- 0.8/1 mm thick. 15 L capacity.
- Removable ashtray at top, black Polyester paint.
- Front opening for bin.
- Easy to empty and clean.
- Black ABS protection bands on base and opening.
- Indoor, Offices, Schools, Medical Clinics, Receptions, Collectivities, etc.



AL82200

- Chapa Poliéster
- Steel Sheet Polyester



AL82201

- Acero Inox Satinado
- Satin Stainless Steel

Características Técnicas Technical Characteristics	AL82200	AL82201
Color Colour	A elegir / Choose	—
Capacidad Volume	(L) 15	15
Peso Neto/Bruto Net/Gross Weight	(Kg) 3,310 / 3,765	3,275 / 3,730

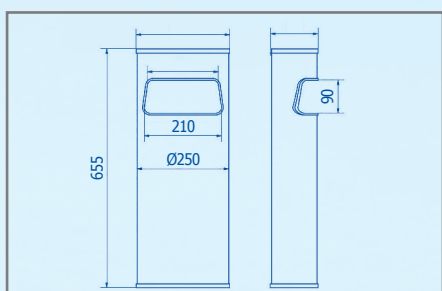

Dimensiones embalaje: (mm) 685
Packaging dimensions: 240 230

PAPELERA SEMICIRCULAR SIN CENICERO HALF ROUND LITTER BIN "CANTON"

AL82211

- Inox.
- Espesor 0,8 mm.
- Capacidad 15 L.
- Apertura frontal para papelera.
- Fácil vaciado y limpieza.
- Junquillo protector en ABS negro en base y boca.
- Tapa superior Inox. abatible con bisagras.
- Interior, Oficinas, Despachos, Consultas, Colegios, Recepciones, Colectividades, etc.
- Stainless Steel.
- 0.8 mm thick.
- 15 L capacity.
- Front opening for bin.
- Easy to empty and clean.
- Black ABS protection bands on base and opening.
- Stainless Steel lid reclining with hinges.
- Indoors, Offices, Medical Clinics, Receptions, Collectivities, etc.

Características Técnicas Technical Characteristics	AL82211
Material Material	Inox / Stainless Steel
Acabado Finish	Satinado / Satin
Capacidad Volume	(L) 15
Peso Neto/Bruto Net/Gross Weight	(Kg) 3,275 / 3,730

- EMBALAJE: Unitario. | PACKAGING: Single.
- LIMPIEZA: Bayeta húmeda. No usar productos químicos. | CLEANING: Damp cloth. Don't use chemicals.



PAPELERA/CENICERO SEMICIRCULAR CUBO INTERIOR ASHTRAY AND LITTER HALF ROUND BIN AL83801 - AL88200 - AL88201 "BANGKOK"

- Inox. o chapa electocincada.
- Pintadas en Poliéster.
- Cenicero y cubo interior pintados en Poliéster.
- Junquillo protector en ABS negro en base y boca.
- Cabezal y cenicero extraíbles.
- Exterior, Interior, etc.
- S.Steel or eletro zinc coated Steel Sheet.
- Polyester paint.
- Ashtray and inner bucket painted with Polyester.
- Black ABS protection bands on base and opening.
- Head and ashtray detachable.
- Outdoors, Indoors, etc.

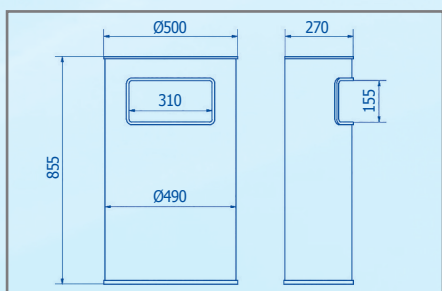

Dimensiones embalaje: (mm) 870
Packaging dimensions: 455 415

- EMBALAJE: Unitario. | PACKAGING: Single.
- LIMPIEZA: Bayeta húmeda. No usar productos químicos. | CLEANING: Damp cloth. Don't use chemicals.



AL83801



AL88200



AL88201

Características Técnicas Technical Characteristics	AL83801	AL88200	AL88201
Material Material	Inox / S.Steel	Chapa / Steel Sheet	Inox / S.Steel
Acabado Finish	Satinado / Satin	Poliéster / Polyester	Satinado / Satin
Color Colour	—	A elegir / Choose	—
Capacidad Volume (L)	50	80	80
Peso Neto/Bruto Net/Gross Weight (Kg)	10,665 / 11,325	16,350 / 17,600	14,450 / 15,295
Espesor Thickness (mm)	0,8	1	0,8



PAPELERA SEMICIRCULAR CUBO INTERIOR HALF ROUND BIN, W/O ASHTRAY AL83811 - AL88210 - AL88211 "PHUKET"

- Inox. o chapa electocincada.
- Cubo interior pintado en Poliéster negro, extraíble.
- Tapa de Inox. abatible, con bisagras.
- Apertura central.
- Junquillo en ABS negro en base y boca.
- Exterior, Centros Comerciales, etc.
- S.Steel or eletro zinc coated Steel Sheet.
- Removable inner bucket, painted with black Polyester paint.
- Reclining S. Steel cover, with hinges.
- Front opening.
- Black ABS protection bands on base and opening.
- Outdoors, Shopping Centres, etc.

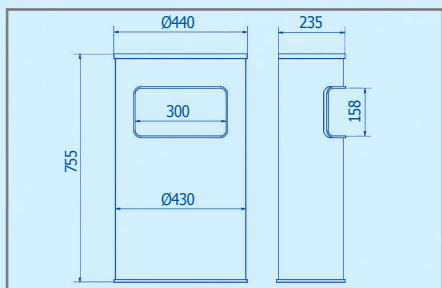

Dimensiones embalaje: (mm) 860
Packaging dimensions: 458 420

- EMBALAJE: Unitario. | PACKAGING: Single.
- LIMPIEZA: Bayeta húmeda. No usar productos químicos. | CLEANING: Damp cloth. Don't use chemicals.



AL83811



AL88210



AL88211

Características Técnicas Technical Characteristics	AL83811	AL88210	AL88211
Material Material	Inox / S.Steel	Chapa / Steel Sheet	Inox / S.Steel
Acabado Finish	Satinado / Satin	Poliéster / Polyester	Satinado / Satin
Color Colour	—	A elegir / Choose	—
Capacidad Volume (L)	50	80	80
Peso Neto/Bruto Net/Gross Weight (Kg)	11,500 / 12,075	14,480 / 15,205	14,450 / 15,175
Espesor Thickness (mm)	0,8	1	0,8

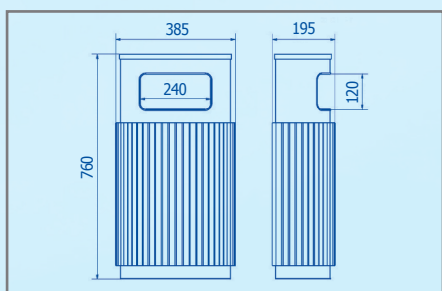

Dimensiones embalaje: (mm) 915
Packaging dimensions: 450 450

PAPELERA/CENICERO SEMICIRCULAR POLIURETANO ASHTRAY AND LITTER HALF ROUND BIN, W/POLYURETHANE AL89001 "SEUL"

- Inox.
- Espesor 0,8 mm.
- Forrada exteriormente con protección de Poliuretano.
- Cenicero superior pintado en Poliéster negro.
- Parte superior extraíble y abertura frontal amplia.
- Capacidad 40 L.
- Junquillo ABS negro en base y boca.
- Cubo interior, metálico, extraíble.
- Exterior, Interior, Parking, Garajes, Grandes Superficies, Centros Comerciales, Oficinas, Despachos, Polideportivos, Colectividades, etc.
- Stainless Steel.
- 0,8 mm thick.
- Externally covered with Polyurethane protection.
- Upper ashtray painted with black Polyester paint.
- Top lid removable, large front opening.
- 40 L capacity.
- Black ABS protection band on base and opening.
- Metallic removable inner bucket.
- Outdoors, Indoors, Car Parks, Garages, Department Stores, Shopping Centers, Offices, Sports Centres, Collectivities, etc.

Características Técnicas | Technical Characteristics

Características Técnicas Technical Characteristics		AL89001
Material Material		Inox / Stainless Steel
Acabado Finish		Satinado / Satin
Capacidad Volume	(L)	40
Peso Neto/Bruto Net/Gross Weight	(Kg)	8,950 / 10,100

- EMBALAJE: Unitario. | PACKAGING: Single.
- LIMPIEZA: Bayeta húmeda. No usar productos químicos. | CLEANING: Damp cloth. Don't use chemicals.

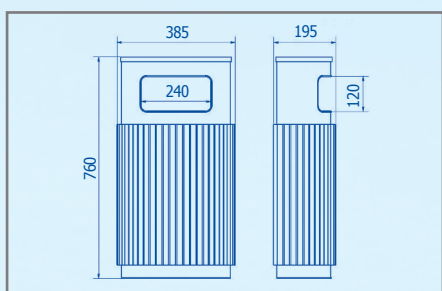

Dimensiones embalaje: (mm) 915
Packaging dimensions: 450 450

PAPELERA SEMICIRCULAR CON POLIURETANO HALF ROUND BIN, W/POLYURETHANE AL89101 "SAPPORO"

- Inox.
- Espesor 0,8 mm.
- Forrada exteriormente con protección de Poliuretano.
- Tapa de Inox, abatible, con bisagras.
- Cubo interior extraíble pintado en Poliéster negro.
- Capacidad 40 L.
- Junquillo negro en base y boca.
- Abertura frontal amplia.
- Tapa Inox, abatible, con bisagras.
- Semicircular.
- Exterior, Interior, Grandes Superficies, Centros Comerciales, Colectividades, Hospitales, Clínicas, Polideportivos, Oficinas, etc.
- Stainless Steel.
- 0,8 mm thick.
- Externally covered with Polyurethane protection.
- Reclining Stainless Steel, cover with hinges.
- Inner bucket painted with black Polyester removable.
- Capacity: 40 L.
- Black ABS protection bands on base and opening.
- Large front opening.
- Reclining S.Steel cover, with hinges.
- Half round shape.
- Indoors, Outdoors, Department Stores, Shopping Centers, Collectivities, Hospitals, Medical Clinics, Sports Centers, Offices, etc.

Características Técnicas | Technical Characteristics

Características Técnicas Technical Characteristics		AL89101
Material Material		Inox / Satinless Steel
Acabado Finish		Satinado / Satin
Capacidad Volume	(L)	40
Peso Neto/Bruto Net/Gross Weight	(Kg)	8,95 / 10,200

- EMBALAJE: Unitario. | PACKAGING: Single.
- LIMPIEZA: Bayeta húmeda. No usar productos químicos. | CLEANING: Damp cloth. Don't use chemicals.

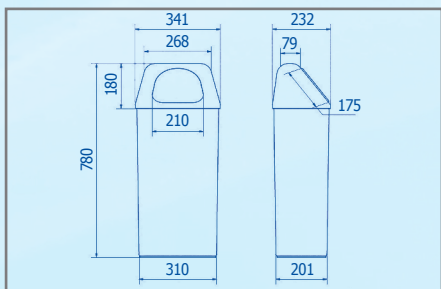

RL2010

Dimensiones embalaje:
Packaging dimensions:

(mm) 617
350 248



PAPELERA PLÁSTICO CON CABEZAL BATIENTE PLASTIC BINS WITH SWING LID

AL70700BG - AL70750BG

"LIMA"

- Fabricada en Polipropileno.
- Cabezal en ABS gris desmontable y extraíble.
- Tapa batiente con resorte de retorno.
- Higiénico, ocultando interior y de fácil limpieza.
- Puede colocarse en altura (AL70750BG) con soporte RL2010.
- Interior, Baños, Aseos, Dispensarios, Consultas, Clínicas, Hospitales, Geriátricos, etc.

- Made of Polypropylene.
- Removable and detachable lid, made of grey ABS.
- Swing lid with return spring.
- Hygienic, waste concealed, easy to clean.
- Can be placed at a certain height (AL70750BG) by means of support RL2010.
- Indoors, Toilets, Bathrooms, Medical Clinics, Hospitals, etc.



AL70700BG

- Polipropileno Blanco/Gris
- Polypropylene White/Grey



AL70750BG

- Polipropileno Blanco/Gris
- Polypropylene White/Grey

Características Técnicas Technical Characteristics	AL70700BG	AL70750BG
Capacidad Volume (L)	40	40
Peso Neto/Bruto Net/Gross Weight (Kg)	2,470 / 2,950	3,065 / 3,545

- EMBALAJE: Unitario. | PACKAGING: Single.
- LIMPIEZA: Bayeta húmeda. No usar productos químicos. | CLEANING: Damp cloth. Don't use chemicals.

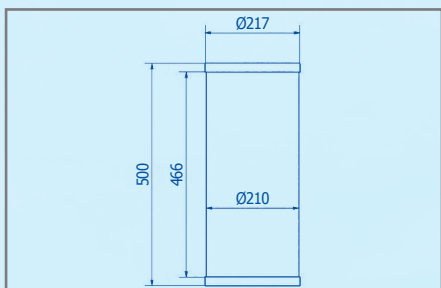

Dimensiones embalaje: (mm) 525
Packaging dimensions: 230 230

PAPELERA ALTA REDONDA CON AROS ROUND HIGH BINS WITH RINGS

AL96000 - AL96001

"ATENAS"

- Inox. o chapa electrocincada.
- Uso Universal.
- Espesor 0,8/1 mm.
- Protección boca y base con junquillo ABS negro o cromado.
- Cilíndrica, robusta y resistente.
- Apoyada sobre el perímetro de la base.
- Interiores, Oficinas, Despachos.

- S.Steel or electro zinc coated Steel Sheet.
- Widespread use.
- 0.8/1 mm thick.
- Upper and lower ABS protection band, black or chrome.
- Cylindrical, robust, resistant.
- Floor standing by base perimeter.
- Indoors, Offices, Medical clinics.



AL96000

- Chapa Poliéster
- Steel Sheet Polyester



AL96001

- Acero Inox Satinado
- Satin Stainless Steel

Características Técnicas Technical Characteristics	AL96000	AL96001
Base Base	ABS	ABS
Color Colour	A elegir / Choose	Inox / Satin S.Steel
Capacidad Volume (L)	20	20
Peso Neto/Bruto Net/Gross Weight (Kg)	2,310 / 2,605	2,195 / 2,505
Junquillo Sup./Inf. Upper/Lower Band	ABS	ABS
Junquillo Acabado Finish Band	Negro / Black	Cromado / Chromed

- EMBALAJE: Unitario. | PACKAGING: Single.
- LIMPIEZA: Bayeta húmeda. No usar productos químicos. | CLEANING: Damp cloth. Don't use chemicals.

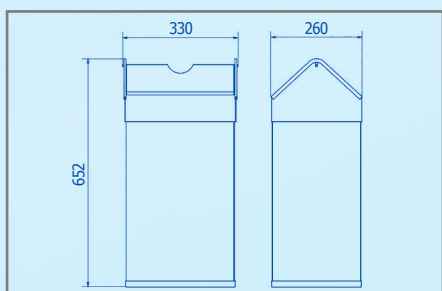

Dimensiones embalaje: (mm) 680
Packaging dimensions: 340 270

PAPELERA/CENICERO TAPA BASCULANTE RECTANGULAR ASHTRAY AND LITTER BIN, SWIVEL LID AL75500 "MEMPHIS"

- Chapa electrocincada.
- Pintadas en Poliéster.
- Colores a elegir.
- Espesor 0,8/1 mm.
- Capacidad 40 L.
- Cabezal con cenicero en forma piramidal desmontable.
- Cuerpo rectangular.
- Tapa basculante, ocultando interior.
- Junquillo ABS negro protector en base y cabezal.
- Interior, Exterior, Oficinas, Grandes Superficies, Horeca, Fábricas, etc.
- Electro zinc coated Steel Sheet.
- Polyester paint.
- Several colours to choose.
- 0.8/1 mm thick.
- 40 L capacity.
- Removable pyramidal shaped top, including ashtray.
- Bin with rectangular shape.
- Lid swivel in both directions, concealing waste inside.
- Black ABS protection bands on base and cover.
- Indoors, Outdoors, Department Stores, Horeca, Industry, Offices, etc.

Características Técnicas | Technical Characteristics

		AL75500
Material Material		Chapa / Steel Sheet
Acabado Finish		Poliéster / Polyester
Peso Neto/Bruto Net/Gross Weight	(Kg)	6,265 / 6,745
Capacidad Volume	(L)	40

- EMBALAJE: Unitario. | PACKAGING: Single.
- LIMPIEZA: Bayeta húmeda. No usar productos químicos. | CLEANING: Damp cloth. Don't use chemicals.

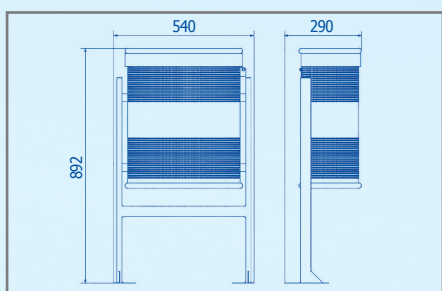

Dimensiones embalaje: (mm) 960
Packaging dimensions: 510 455

PAPELERA SEMICIRCULAR FIJADA A SUELO POST MOUNTED HALF ROUND BIN AL81340 "MANILA"

- Chapa electrocincada.
- Pintada en Poliéster.
- Colores a elegir.
- Capacidad 40 L.
- Espesor 1 mm.
- Abatible para vaciado.
- Antivandálica.
- Fijada a suelo con dos patas atornilladas.
- Aro superior para sujeción bolsa desechable.
- Cuerpo central compacto y superior e inferior perforado.
- Interior, Exterior, Parques, Jardines, Urbanos, etc.
- Electro zinc coated Steel Sheet.
- Polyester paint.
- Several colours to choose.
- Capacity: 40 L.
- 1 mm thick.
- Reclining for emptying.
- Antivandalism.
- Fixed to floor with two legs screwed.
- Upper ring to hold disposable bags.
- Middle stripe compact, upper and lower perforated.
- Indoors, Outdoors, Parks, Gardens, Urban Environment, etc.

Características Técnicas | Technical Characteristics

		AL81340
Material Material		Chapa / Steel Sheet
Acabado Finish		Poliéster / Polyester
Color Colour		A elegir / Choose
Peso Neto/Bruto Net/Gross Weight	(Kg)	9,950 / 11,400

- FIJACIÓN: A suelo mediante 6 tornillos + 6 tacos (incluidos). | FIXING: To floor with 6 screws + 6 wall plugs (included).
- EMBALAJE: Unitario. | PACKAGING: Single.
- LIMPIEZA: Bayeta húmeda. No usar productos químicos. | CLEANING: Damp cloth. Don't use chemicals.



PAPELERA INOX CABEZAL BATIENTE STAINLESS STEEL BINS, SWING LID "PUSH" AL72025SV - AL72035SV - AL72050SV "OSLO"

- Cabezal Acero Inox AISI 304.
- Cabezal semiesférico desmontable a presión.
- Carcasa Acero Inox AISI 410.
- Tapa batiente "Push" con muelle.
- Junquillo en el perímetro de su base.
- Diseñada para colocar bolsa en interior.
- Lid Stainless Steel AISI 304.
- Head with hemispherical shape, removable by pressing.
- Frame in Stainless Steel AISI 410.
- Swing cover "Push", with spring.
- Protection band around base.
- Conceived to put waste bins inside.

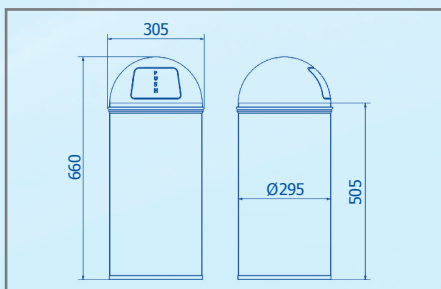

Dimensiones embalaje: (mm) 600
Packaging dimensions: 315

- EMBALAJE: Unitario. | PACKAGING: Single.
- LIMPIEZA: Bayeta húmeda. No usar productos químicos. | CLEANING: Damp cloth. Don't use chemicals.



AL72025SV



AL72035SV



AL72050SV

Características Técnicas Technical Characteristics	AL72025SV	AL72035SV	AL72055SV
Carcasa Cover	Acero Inox AISI 410 Stainless Steel AISI 410	Acero Inox AISI 410 Stainless Steel AISI 410	Acero Inox AISI 410 Stainless Steel AISI 410
Cabezal Lid	Acero Inox AISI 304 Stainless Steel AISI 304	Acero Inox AISI 304 Stainless Steel AISI 304	Acero Inox AISI 304 Stainless Steel AISI 304
Acabado Finish	Brillo / Bright	Brillo / Bright	Brillo / Bright
Peso Neto/Bruto Net/Gross Weight (Kg)	1,550 / 2,300	2,050 / 2,900	2,850 / 4,050
Capacidad Volume (L)	25	35	50



PAPELERA INOX CABEZAL BASCULANTE STAINLESS STEEL BINS, SWIVEL LID AL74025SV - AL74040SV "MILAN"

- Cabezal en Acero Inox AISI 410.
- Cabezal plano desmontable.
- Tapa basculante.
- Carcasa en Acero Inox AISI 410.
- Diseñada para colocar bolsas en su interior.
- Lid Stainless Steel AISI 410.
- Flat head, removable.
- Swivel lid.
- Frame in Stainless Steel AISI 410.
- Conceived to put waste bins inside.

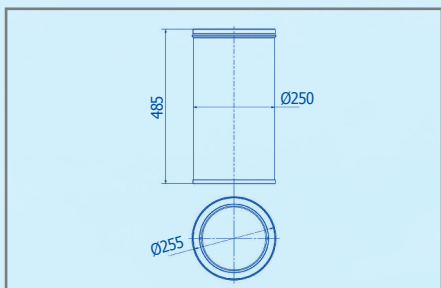

Dimensiones embalaje: (mm) 500
Packaging dimensions: 270

- EMBALAJE: Unitario. | PACKAGING: Single.
- LIMPIEZA: Bayeta húmeda. No usar productos químicos. | CLEANING: Damp cloth. Don't use chemicals.



AL74025SV

- Acero Inox Brillo
- Bright Stainless Steel



AL74040SV

- Acero Inox Brillo
- Bright Stainless Steel

Características Técnicas Technical Characteristics	AL74025SV	AL74040SV
Carcasa Cover	Acero Inox AISI 410 Stainless Steel AISI 410	Acero Inox AISI 410 Stainless Steel AISI 410
Cabezal Lid	Acero Inox AISI 410 Stainless Steel AISI 410	Acero Inox AISI 410 Stainless Steel AISI 410
Acabado Finish	Brillo / Bright	Brillo / Bright
Peso Neto/Bruto Net/Gross Weight (Kg)	1,500 / 2,250	2,770 / 3,860
Capacidad Volume (L)	25	40

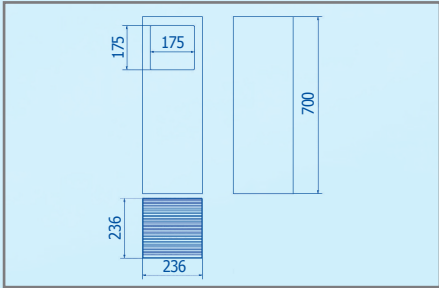

Dimensiones embalaje: (mm) 705
Packaging dimensions: 241

- EMBALAJE: Unitario. | PACKAGING: Single.
- LIMPIEZA: Bayeta húmeda. No usar productos químicos. | CLEANING: Damp cloth. Don't use chemicals.

PAPELERA/CENICERO CUADRADA SQUARE BINS WITH ASHTRAY

AL709100 - AL709101 - AL709200 - AL709201 "MICHIGAN"

- Espesor de 0,8/1 mm.
- Cenicero superior extraíble con arena o lamas Aluminio.
- Amplia boca central.
- Sistema sujeción bolsa interior.
- Grandes Superficies, etc.

- 0.8/1mm thick.
- Removable top ashtray for sand, or with Aluminum slats.
- Large front opening.
- Internal system to fix bag.
- Department Stores, etc.



AL709100

- Chapa
- Steel Sheet



AL709101

- Inox
- Stainless Steel



AL709200

- Chapa
- Steel Sheet



AL709201

- Inox
- Stainless Steel

Características Técnicas Technical Characteristics	AL709100	AL709101	AL709200	AL709201
Material Material	Chapa / S.Sheet	Inox / S.Steel	Chapa / S.Sheet	Inox / S.Steel
Acabado Finish	Poliéster / Polyester	Satinado / Satin	Poliéster / Polyester	Satinado / Satin
Color Colour	A elegir / Choose	—	A elegir / Choose	—
Capacidad Volume	(L) 40	40	40	40
Peso Neto/Bruto Net/Gross Weight	(Kg) 4,955 / 5,750	4,955 / 5,750	4,955 / 5,750	4,955 / 5,750
Cenicero Ashtray	Lamas / Slats	Arena / Sand	Lamas / Slats	Arena / Sand

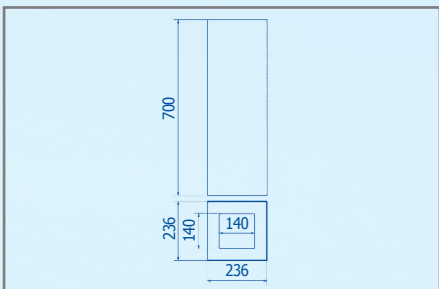

Dimensiones embalaje: (mm) 705
Packaging dimensions: 241

PAPELERA CUADRADA SQUARE BINS

AL709300 - AL709301

"BOSTON"

- Inox. o chapa electrocincada.
- Pintura de Poliéster.
- Espesor de 0,8/1 mm.
- Boca superior en Inox. extraíble.
- Sistema sujeción bolsa interior.
- Centros Comerciales, Grandes Superficies, etc.

- S.Steel or electro zinc coated Steel Sheet.
- Polyester paint.
- 0.800/1 mm thick.
- Removable head with upper opening, made of Stainless Steel.
- Internal system to fix bag.
- Shopping Centers, etc.



AL709300

- Chapa Poliéster
- Steel Sheet Polyester



AL709301

- Acero Inox Satinado
- Satin Stainless Steel

Características Técnicas Technical Characteristics	AL709300	AL709301
Color Colour	A elegir / Choose	—
Capacidad Volume	(L) 40	40
Peso Neto/Bruto Net/Gross Weight	(Kg) 4,955 / 5,750	4,955 / 5,750
Base Base	Tacos Goma Rubber Pads	Tacos Goma Rubber Pads

- EMBALAJE: Unitario. | PACKAGING: Single.
- LIMPIEZA: Bayeta húmeda. No usar productos químicos. | CLEANING: Damp cloth. Don't use chemicals.

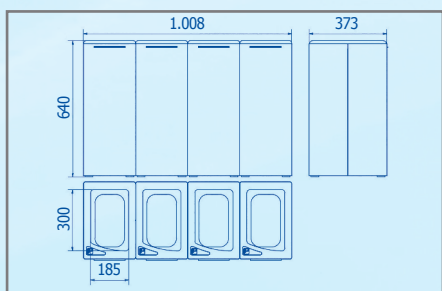

Dimensiones embalaje: (mm) 650
Packaging dimensions: 303 475

PAPELERAS SELECTIVAS MODULARES ABIERTAS MODULAR SELECTIVE BINS, OPEN TOP

AL707050 (A-V-Z-G) / AL707051 (A-V-Z-G)

"AUSTIN"

• PEDIDOS

- Material

- Standard: Chapa galvanizada
- Poliéster Gris Oxidón: AL 707050
- Acero Inox. Satinado: AL707051

- Módulo y color

- Añadiendo a la ref. las iniciales de los colores elegidos:
AL.....(A-V-Z-G.....)
Ej.: AL707050 AZG (3 mod.)

• ORDERS

- Material

- Standard: Galvanised sheet
- Polyester Grey Oxidón: AL 707050
- Stainless Steel. Satin: AL707051

- Unit and colour

- Adding to the reference, the initials of the colours chosen:
AL.....(A-V-Z-G.....)
Ej.: AL707050 AZG (3 mod.)

- Inox. o chapa galvanizada.
- Pintadas en Poliéster gris oxidón (standard) o color a elegir.
- Boca superior abierta.
- Cada módulo, depósito de Polipropileno de 40 L de color.
- Cerradura superior con llave para fijación depósito y seguridad.
- Patas niveladoras regulables e independientes.
- Patas rosca metálica, terminadas en apoyo plástico.
- Encimera plástico de cierre de color identificativo.
- Encimera con pictograma metálico indicativo.
- Encimera extraíble, ocultando sujeción bolsa y depósito.
- Diseñadas para combinar módulos y formar papeleras selectivas.
- Unión de módulos con tornillos, tuercas y pasador ocultos.
- Los módulos se pueden unir y desmontar fácilmente.
- Se pueden realizar tantas combinaciones y uniones de módulos como se quieran y posterior desmontaje y reutilización.
- Cada dos módulos se suministran los elementos de unión.
- Los depósitos e interiores son de diferentes colores y a juego con la encimera, conformando sus iniciales la referencia del módulo (A=Amarillo, V=Verde, G=Gris, Z= Azul, T=Transparente B=Blanco).
- El pedido y el precio de tarifa, siempre es por módulo y color unitario.
- Posibilidad, sobre pedido, fabricación en Acero Inox. Satinado (Ref. AL707051.....) con precios en Tarifa.
- Diseñadas para reciclaje selectivo de todo tipo de residuos.
- Centros Comerciales, Grandes Superficies, Colectividades, etc.
- Stainless Steel or galvanized coated Steel Sheet, 1 mm.
- Standard bin painted with Polyester paint, grey oxidon (standard) and other colours available.
- Upper opening.
- Each unit includes Polypropylene deposit, 40 L capacity, different colours.
- Key lock to fix deposit and cover to the bin, high security.
- Adjustable legs, independent.
- Legs with metallic thread, plastic end.
- Plastic top cover with identifying colour.
- Top cover with identifying metallic pictogram.
- Removable cover, hiding bag holder and deposit.
- Designed to combine different units and form recycling unit.
- Units joined together by means of screws, bolts and nuts concealed.
- Units are easy to join and disassemble.
- It is possible to join together as many units as desired, and disassemble them afterwards to use otherwise.
- Every two units bought joining elements are provided.
- Inner deposits are of different colours and match plastic cover, initials of the colour complete the product reference (A=Yellow, V=Green, G=Grey, Z= blue, T=Transparent B=White).
- Order and price of price list corresponds to each unit and colour.
- Upon request can be manufactured from Stainless Steel, satin finish (Ref. AL707051.....) for the price included on price list.
- Designed for selective collection of all type of waste.
- Shopping centres, Department Stores, Collectivities, etc.

Características Técnicas Technical Characteristics	AL707050 1 mod.	AL707050 2 mod.	AL707050 3 mod.	AL707051 1 mod.	AL707051 2 mod.	AL707051 3 mod.
Material Material	Chapa / S.Sheet	Chapa / S.Sheet	Chapa / S.Sheet	Inox / S.Steel	Inox / S.Steel	Inox / S.Steel
Acabado Finish	Poliéster / Polyester	Poliéster / Polyester	Poliéster / Polyester	Satinado / Satin	Satinado / Satin	Satinado / Satin
Color Colour (Standard)	Gris Oxidón / Grey	Gris Oxidón / Grey	Gris Oxidón / Grey	—	—	—
Capacidad Volume (L)	40	80	120	40	80	120
Peso Neto/Bruto Net/Gross Weight (Kg)	9,210 / 10,260	18,420 / 20,520	27,630 / 30,780	7,395 / 8,400	14,790 / 16,800	22,185 / 25,200
Espesor Thickness (mm)	1	1	1	0,8	0,8	0,8

• EMBALAJE: Unitario.
PACKAGING: Single.

• LIMPIEZA: Bayeta húmeda. No usar productos químicos.
CLEANING: Damp cloth. Don't use chemicals.

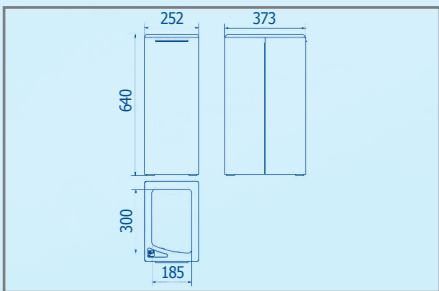

Dimensiones embalaje: (mm) 660
Packaging dimensions: 303 475

• PEDIDOS

- Material

- Standard: Chapa galvanizada
- Poliéster Gris Oxidón: AL 707550
- Acero Inox. Satinado: AL707551

- Módulo y color

- Añadiendo a la ref. las iniciales de los colores elegidos:
AL.....(A-V-Z-G.....)
Ej.: AL707550 AZG (3 mod.)

• ORDERS

- Material

- Standard: Galvanised sheet
- Polyester Grey Oxidón: AL 707550
- Stainless Steel. Satin: AL707551

- Unit and colour

- Adding to the reference, the initials of the colours chosen:
AL.....(A-V-Z-G.....)
Ej.: AL707550 AZG (3 mod.)

**PAPELERAS SELECTIVAS MODULARES TAPA OSCILANTE
MODULAR SELECTIVE BINS, SWIVEL LID
AL707550 (A-V-Z-G) / AL707551 (A-V-Z-G) "BALTIMORE"**

- Inox. o chapa galvanizada.
- Pintadas en Poliéster gris oxidón (standard) o color a elegir.
- Espesor 0,8/1 mm.
- Tapa superior oscilante en Inox.
- Cada módulo, depósito de Polipropileno de 40 L de color.
- Cerradura superior con llave para fijación depósito y seguridad.
- Patas niveladoras regulables e independientes.
- Patas rosca metálica, terminadas en apoyo plástico.
- Encimera plástico de cierre de color identificativo.
- Encimera con pictograma metálico indicativo.
- Encimera extraíble, ocultando sujeción bolsa y depósito.
- Diseñado para combinar módulos y formar papeleras selectivas.
- Unión de módulos con tornillos, tuercas y pasador ocultos.
- Los módulos se pueden unir y desmontar fácilmente.
- Se pueden realizar tantas combinaciones y uniones de módulos como se quieran y posterior desmontaje y reutilización.
- Cada dos módulos se suministran los elementos de unión.
- Los depósitos e interiores son de diferentes colores y a juego con la encimera, conformando sus iniciales la referencia del módulo (A=Amarillo, V=Verde, G=Gris, Z=Azul, T=Transparente B=Blanco).
- El pedido y el precio de tarifa, siempre es por módulo y color unitario.
- Diseñados para reciclaje selectivo de todo tipo de residuos.
- Centros Comerciales, Grandes Superficies, Colectividades, etc.
- Stainless Steel or galvanized coated Steel Sheet.
- Bin painted with Polyester paint, grey oxidón (standard) and other colours available.
- 0,8/1 mm thick.
- Stainless Steel lid swivel.
- Each unit, Polypropylene deposit with 40 L capacity of colours.
- Key lock to fix deposit and cover to the bin for higher security.
- Adjustable legs, independent.
- Legs with metallic thread, plastic end.
- Plastic top cover with identifying colour.
- Top cover with identifying metallic pictogram.
- Removable cover, hiding bag holder and deposit.
- Designed to combine different units and form recycling unit.
- Units joined together by means of screws, bolts and nuts concealed.
- Units are easy to join and disassemble.
- It is possible to join together as many units as desired, and disassemble them afterwards to use otherwise.
- Every two units bought joining elements are provided.
- Inner deposits are of different colours and match plastic cover, initials of the colour complete the product reference (A=Yellow, V=Green, G=Grey, Z=Blue, T=Transparent B=White).
- Order and price of price list corresponds to each unit and colour.
- Designed for selective collection of all type of waste.
- Shopping centres, department Stores, collectivities, etc.

Características Técnicas Technical Characteristics	AL707550 1 mod.	AL707550 2 mod.	AL707550 3 mod.	AL707551 1 mod.	AL707551 2 mod.	AL707551 3 mod.
Material Material	Chapa / S.Sheet	Chapa / S.Sheet	Chapa / S.Sheet	Inox / S.Steel	Inox / S.Steel	Inox / S.Steel
Acabado Finish	Poliéster / Polyester	Poliéster / Polyester	Poliéster / Polyester	Satinado / Satin	Satinado / Satin	Satinado / Satin
Color Colour (Standard)	Gris Oxidón / Grey	Gris Oxidón / Grey	Gris Oxidón / Grey	-	-	-
Capacidad Volume (L)	40	80	120	40	80	120
Peso Neto/Bruto Net/Gross Weight (Kg)	9,700 / 10,750	19,400 / 21,500	29,100 / 32,250	7,885 / 8,910	15,770 / 17,820	23,655 / 26,730
Espesor Thickness (mm)	1	1	1	0,8	0,8	0,8

• EMBALAJE: Unitario.
PACKAGING: Single.

• LIMPIEZA: Bayeta húmeda. No usar productos químicos.
CLEANING: Damp cloth. Don't use chemicals.

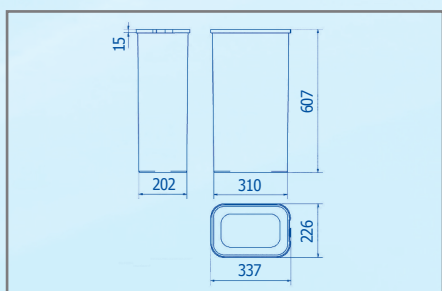

Dimensiones embalaje: (mm) 610
Packaging dimensions: 340 230

DEPÓSITOS SELECTIVOS MODULARES PLÁSTICO PLASTIC MODULAR SELECTIVE BINS

RM1004 (A-B-G-T-V-Z) / RM1006

"CUZCO"

- Polipropileno.
 - Colores a elegir.
 - Colores standard: A=Amarillo, B=Blanco, G=Gris, Z= Azul, V=Verde, T=Transparente .
 - Capacidad 40 L.
 - Geometría rectangular y apilables.
 - Fácil limpieza, mantenimiento y transporte.
 - Muy resistentes y de larga duración.
 - Fleje de unión de depósito (RM1006), para unirlos en batería.
 - Se desmontan fácilmente.
 - Se utilizarán como Papeleras Selectivas Modulares "Low Cost".
 - Los colores standard identifican los tipos de residuos.
 - Abrazadera de unión en Inox (RM1006).
 - General, Centros Comerciales, Grandes Superficies, Colectividades, Horeca, etc.
- Polypropylene.
 - Several colours to choose.
 - Standard colours: A= Yellow, B=White, G=Grey, Z=Blue, G=Green, T=Transparent.
 - 40 L capacity.
 - Rectangular shape and stackable.
 - Easy to clean, maintain and transport.
 - Highly resistant, long lasting life.
 - Hoop joint to join containers (RM1006) and put them together on a line.
 - Easy to disassemble.
 - Used as selective bins, "Low cost".
 - Different colours to identify different types of waste.
 - Hoop joint made of inox (RM1006).
 - General, Shopping Centres, Department Stores, Collectivities, Horeca, etc.



RM1006

• PEDIDOS

Cada módulo tiene igual precio unitario en Tarifa.

Es preciso añadir por cada dos módulos, el precio y la referencia RM-1006 (unión) para el cálculo final.

REFERENCIA: RM-1004
MODULO: Se añadirá a la referencia anterior, las letras de los colores asignados para formar la batería de módulos. Habrá tantos módulos como letras acompañen a la referencia.

Ejemplo: RM-1004 AZVG
(4 módulos: A-Z-V-G)
+ 3 piezas unión RM-1006
Precio: 4 módulos RM-1004
+ 3 piezas unión RM-1006.

• ORDERS

All the units have the same price on price list.

Price and reference RM-1004 (hoop joint) must be added every two units for final calculations.

REFERENCIA: RM-1004
UNIT: You must add to previous reference letter of the colours used to create the whole container. There will be as many units as letters placed behind the reference.

Example: RM-1004 AZVG
(4 units: A-Z-V-G)
+ 3 hoop joints RM-1006
Prix: 4 units RM-1004
+ 3 hoop joints RM-1006.

Características Técnicas Technical Characteristics	RM 1 mod.	RM 2 mod.	RM 3 mod.	RM 4 mod.
Material Material	Polipropileno Polypropylene	Polipropileno Polypropylene	Polipropileno Polypropylene	Polipropileno Polypropylene
Color Colour (Standard)	A elegir / Choose	A elegir / Choose	A elegir / Choose	A elegir / Choose
Capacidad Volume (L)	40	80	120	160
Peso Neto/Bruto Net/Gross Weight (Kg)	2,150 / 2,950	4,300 / 5,900	6,450 / 8,850	8,600 / 11,800

• EMBALAJE: Unitario.
PACKAGING: Single.

• LIMPIEZA: Bayeta húmeda. No usar productos químicos.
CLEANING: Damp cloth. Don't use chemicals.

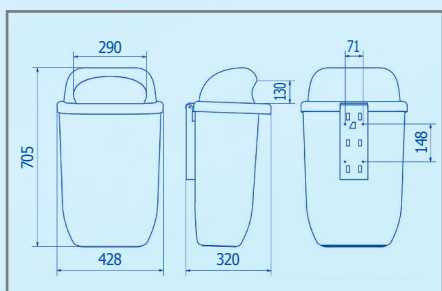

Dimensiones embalaje: (mm) 730
Packaging dimensions: 435 350

PAPELERA URBANA DE PLÁSTICO PLASTIC URBAN LITTER BIN

AL70760

"CANCUN"

- Fabricada en plástico HDPE verde.
- Fijación a pared o a soporte metálico (AL70762).
- Cerradura de seguridad oculta, con llave.
- Chapa frontal metálica para cigarrillos.
- Cabezal desmontable para limpieza y vaciado.
- Cabezal tipo visera para proteger del agua.

- Made of green HDPE plastic material.
- Fixed wall or post mounted with metallic post (AL70762).
- Security lock hidden, with key.
- Metal plate at front to put out cigarettes.
- Lid removable for cleaning and emptying.
- Protected from water by a pick.

Características Técnicas | Technical Characteristics

		AL70760
Material Material		Chapa / Steel Sheet
Acabado Finish		Poliéster / Polyester
Color Colour		A elegir / Choose
Capacidad Volume	(L)	40
Peso Neto/Bruto Net/Gross Weight	(Kg)	8,920 / 10,140

- FIJACIÓN: 2 tornillos (incluidos). | FIXING: 2 screws (included).
- EMBALAJE: Unitario. | PACKAGING: Single.
- LIMPIEZA: Bayeta húmeda. No usar productos químicos. | CLEANING: Damp cloth. Don't use chemicals.

TABLA DE COLORES DISPONIBLES AVAILABLE COLOURS TABLE

Colores Standard / Standard Colours	
RAL 9010	
RAL 9005	
RAL 7024	
RAL 9006	

COLORES ESPECIALES / SPECIAL COLOURS			
RAL 1003		RAL 8017	
RAL 5002		RAL 2004	
RAL 5010		RAL 3000	
RAL 1013		RAL 3005	
RAL 7011		RAL 6001	
RAL 7040		RAL 6005	
RAL 7030-0		RAL 3005-0	

• Estos colores son una simulación cromática únicamente válida como guía visual orientativa. • These colours are a chromatic simulation only valid as a guiding visual guide.



CARRO PORTABOLSAS BAG HOLDER TROLLEY

AL71400 - AL71412

"DENVER"

- Chapa electrocincada.
- Pintado en Poliéster blanco.
- Tubo Ø 12 mm, 4 tubos.
- Tapa metálica abatible accionada por pedal.
- 4 ruedas dobles (8).
- Interior, Horeca, Industria, Talleres, Hospitales, Clínicas, Geriátricos, etc

- Electro zinc coated Steel Sheet.
- White Polyester paint.
- Tube Ø 12 mm, 4 tubes.
- Reclining metallic cover pedal operated.
- 4 double castors (8).
- Indoors, Horeca, Industry, Ateliers, Hospitals, Medical Clinics, etc.

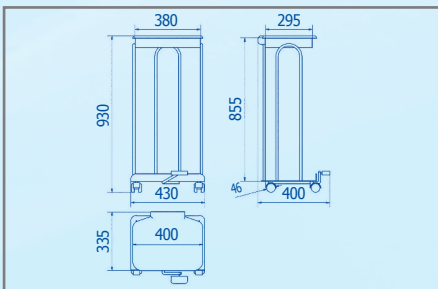

Dimensiones embalaje: (mm) 995
Packaging dimensions: 450 415



AL71400

- Chapa Poliéster
- Steel Sheet Polyester



AL71412

- Chapa Poliéster
- Sheet Polyester

Características Técnicas Technical Characteristics	AL71400	AL71412
Color Colour	Blanco / White	Blanco / White
Capacidad Volume (L)	80	120
Peso Neto/Bruto Net/ Gross Weight (Kg)	6,320 / 7,500	7,435 / 8,650
Ruedas Wheels	2 x 4 = 8	2 x 4 = 8
Tapa Cover	Abatible / Reclining	Abatible / Reclining

- EMBALAJE: Unitario. | PACKAGING: Single.
- LIMPIEZA: Bayeta húmeda. No usar productos químicos. | CLEANING: Damp cloth. Don't use chemicals.



CONTENEDOR INDUSTRIAL DE BASURA GARBAGE INDUSTRIAL CONTAINERS

AL707100 - AL707120

"MONTEVIDEO"

- Fabricado en HDPE negro.
- Apilables.
- Apertura total tapa superior: manual o pedal.
- Dos ruedas de Ø 200 mm desmontables.
- Capacidad: 100/120 L. con 6 adhesivos/pictogramas (no incluidos).
- Pedal de chapa de acero galvanizado color gris, desmontable.
- Horeca, Industria, Taller, Hospitales...

- Made of black HDPE.
- Stackable.
- Top lid opens completely : manually or by pedal.
- Two removable wheels, Ø 200 mm.
- Capacity: 100/120 L, 6 pictograms (not included).
- Removable galvaniseed Steel pedal, made of grey steel sheet.
- Horeca, Industry, Garages, Hospitals...

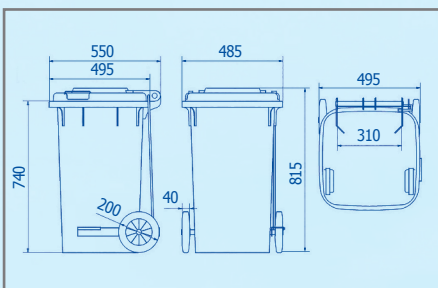

Dimensiones embalaje: (mm) 960
Packaging dimensions: 505 565



AL707100

- Polietileno (HDPE) Negro
- Polyethylene (HDPE) Black



AL707120

- Polietileno (HDPE) Negro
- Polyethylene (HDPE) Black

Características Técnicas Technical Characteristics	AL707100	AL707120
Capacidad Volume (L)	100	120
Peso Neto/Bruto Net/Gross Weight (Kg)	7,400 / 8,860	8,800 / 10,300
Ruedas Wheels	2	2

- EMBALAJE: Unitario. | PACKAGING: Single.
- LIMPIEZA: Bayeta húmeda. No usar productos químicos. | CLEANING: Damp cloth. Don't use chemicals.

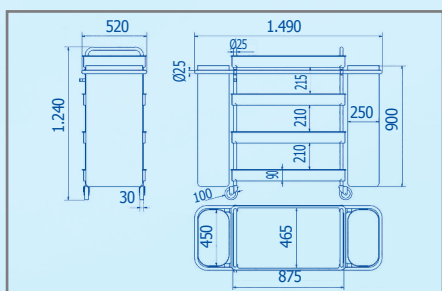

Dimensiones embalaje: (mm) 530
Packaging dimensions: 1.110 460

CARRO METÁLICO. 4 BANDEJAS GRANDES Y 2 BOLSAS METAL TROLLEY. 4 BIG TRAYS AND 2 BAGS AL50050

- Tubo de Inox. Ø 25 mm y 1 mm espesor.
- 4 Bandejas Polipropileno con alzado lateral, color gris.
- 2 Bolsas nylon laterales extraíbles color azul.
- Capacidad bolsas 2 x 100 L.
- 4 Ruedas giratorias libres Ø 100 mm y 32 mm ancho rodadura goma.
- Ruedas antihilos con núcleo de Polipropileno.
- Totalmente desmontable.
- Freno pedal sobre la rueda.
- Colectividades, Hospitales, Clínicas, Geriátricos, Hoteles, etc.
- Stainless Steel tube, Ø 25 mm and 1 mm thick.
- 4 grey Polypropylene shelves with lateral elevation.
- 2 blue nylon removable bags at the sides.
- Bags capacity: 2 x 100 L
- 4 free rotating castors with Ø 100 mm and 32 mm rubber tread.
- Anti-thread castors with Polypropylene core.
- Fully detachable.
- Brake pedal at one castor.
- Collectivities, hospitals, Medical Clinics, Geriatrics, Hotels, etc.

Características Técnicas | Technical Characteristics

		AL50050
Material Estructura Structure Material		Inox / Stainless Steel
Acabado Finish		Satinado / Satin
Material Bandejas Trays Material		Polipropileno / Polypropylene
Material Bolsas Bags Material		PVC
Peso Neto/Bruto Net/Gross Weight	(Kg)	21,650 / 24,200

- Hoja instrucciones de montaje y componentes. | Instructions and components (included).
- EMBALAJE: Unitario. | PACKAGING: Single.
- LIMPIEZA: Bayeta húmeda. No usar productos químicos. | CLEANING: Damp cloth. Don't use chemicals.

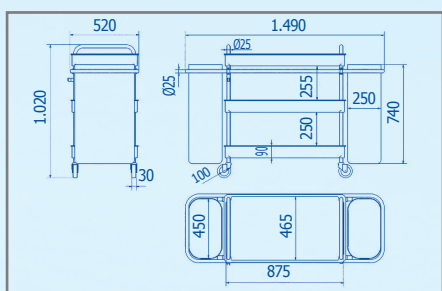

Dimensiones embalaje: (mm) 535
Packaging dimensions: 930 390

CARRO METÁLICO. 3 BANDEJAS GRANDES Y 2 BOLSAS METAL TROLLEY. 3 BIG TRAYS AND 2 BAGS AL50150

- Tubo Inox. Ø 25 mm y 1 mm espesor.
- 3 Bandejas Polipropileno con alzado lateral color gris.
- 2 Bolsas nylon laterales, extraíbles color azul.
- Capacidad bolsas: 2 x 75 L.
- 4 Ruedas giratorias libres Ø 100 mm antihilos.
- Ruedas 32 mm ancho rodadura goma con núcleo de Polipropileno.
- Totalmente desmontables.
- Freno pedal sobre la rueda.
- Horeca, Hoteles, Geriátricos, Residencias, Hospitales, Clínicas, etc.
- Stainless Steel tube with Ø 25 mm and 1 mm thick.
- 3 grey Polypropylene shelves with lateral elevation.
- 2 blue nylon removable bags at both sides.
- Bags capacity: 2 x 75 L.
- 4 free rotating castors with Ø 100 mm, anti-thread.
- Castors with 32 mm wide rubber tread, Polypropylene core.
- Fully detachable.
- Brake pedal at one castor.
- Horeca, hotels, geriatric hospitals, hostels, hospitals, medical clinics, etc.

Características Técnicas | Technical Characteristics

		AL50150
Material Estructura Structure Material		Inox / Stainless Steel
Acabado Finish		Satinado / Satin
Material Bandejas Trays Material		Polipropileno / Polypropylene
Material Bolsas Bags Material		PVC
Peso Neto/Bruto Net/Gross Weight	(Kg)	17,750 / 19,750

- Hoja instrucciones de montaje y componentes. | Instructions and components (included).
- EMBALAJE: Unitario. | PACKAGING: Single.
- LIMPIEZA: Bayeta húmeda. No usar productos químicos. | CLEANING: Damp cloth. Don't use chemicals.

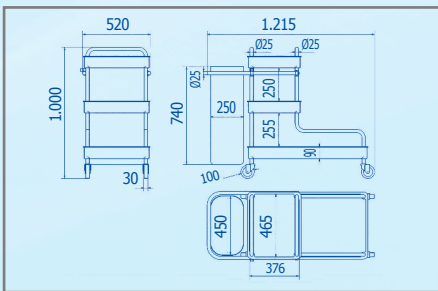

Dimensiones embalaje: (mm) 535
Packaging dimensions: 930 390

CARRO METÁLICO. 1 BANDEJA GRANDE 2 BANDEJAS PEQUEÑAS Y 1 BOLSA METAL TROLLEY. 1 BIG TRAYS, 2 LITTLE TRAYS AND 1 BAG AL50250

- Tubo Inox. Ø 25 mm y 1 mm espesor.
- 3 Bandejas Polipropileno con alzado lateral color gris (1+2).
- 1 Bolsa nylon lateral, extraíble color azul.
- Capacidad bolsa 75 L.
- 4 Ruedas giratorias libres Ø 100 mm antihilos.
- Ruedas 32 mm ancho rodadura goma con núcleo de Polipropileno.
- Totalmente desmontables.
- Freno pedal sobre la rueda.
- Puede transportar cubo fregona.
- Horeca, Hoteles, Hospitales, etc.
- Stainless Steel tube with Ø 25 mm and 1 mm thick.
- 3 grey Polypropylene bags with lateral elevation (1+2).
- 1 Blue nylon removable bag.
- Bag Capacity: 75 L.
- 4 free rotating castors with Ø 100 mm, anti-thread.
- Castors with 32 mm wide rubber tread, Polypropylene core.
- Entirely detachable.
- Brake pedal at one castor.
- Can carry mop bucket.
- Horeca, Hotels, Hospitals, etc.

Características Técnicas Technical Characteristics	AL50250
Material Estructura Structure Material	Inox / Stainless Steel
Acabado Finish	Satinado / Satin
Material Bandejas Trays Material	Polipropileno / Polypropylene
Material Bolsas Bags Material	PVC
Peso Neto/Bruto Net/Gross Weight (Kg)	13,600 / 15,650

- Hoja instrucciones de montaje y componentes. | Instructions and components (included).
- EMBALAJE: Unitario. | PACKAGING: Single.
- LIMPIEZA: Bayeta húmeda. No usar productos químicos. | CLEANING: Damp cloth. Don't use chemicals.

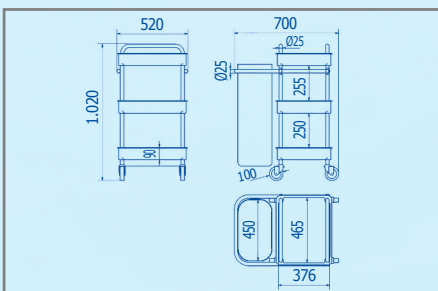

Dimensiones embalaje: (mm) 930
Packaging dimensions: 510 200

CARRO METÁLICO. 3 BANDEJAS PEQUEÑAS Y 1 BOLSA METAL TROLLEY. 3 LITTLE TRAYS AND 1 BAG AL50350

- Tubo Inox. Ø 25 mm y 1 mm espesor.
- 3 Bandejas Polipropileno con alzado lateral color gris.
- 1 Bolsa nylon lateral, extraíble.
- Capacidad bolsa 75 L.
- 4 Ruedas giratorias libres Ø 100 mm y 32 mm ancho rodadura goma.
- Ruedas antihilos con núcleo de Polipropileno.
- Totalmente desmontables.
- Freno pedal sobre la rueda.
- Colectividades, Hospitales, Clínicas, Geriátricos, Hoteles, Residencias, etc.
- Stainless Steel tube with Ø 25 mm and 1 mm thick
- 3 grey Polypropylene shelves, with lateral elevation.
- 1 nylon removable bag at one side.
- Bag capacity: 75 L.
- 4 free rotating castors with Ø 100 mm and 32 mm wide rubber tread.
- Anti-thread castors with Polypropylene core.
- Entirely detachable.
- Brake pedal at one castor.
- Collectivities, hospitals, medical clinics, geriatric hospitals, hotels, etc.

Características Técnicas Technical Characteristics	AL50350
Material Estructura Structure Material	Inox / Stainless Steel
Acabado Finish	Satinado / Satin
Material Bandejas Trays Material	Polipropileno / Polypropylene
Material Bolsas Bags Material	PVC
Peso Neto/Bruto Net/Gross Weight (Kg)	11,750 / 13,000

- Hoja instrucciones de montaje y componentes. | Instructions and components (included).
- EMBALAJE: Unitario. | PACKAGING: Single.
- LIMPIEZA: Bayeta húmeda. No usar productos químicos. | CLEANING: Damp cloth. Don't use chemicals.

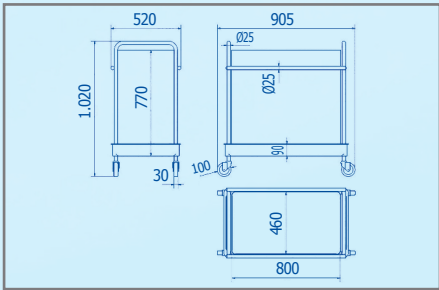

Dimensiones embalaje: (mm) 930
Packaging dimensions: 510 200

CARRO METÁLICO. 1 BANDEJA GRANDE Y 1 BOLSA METAL TROLLEY. 1 BIG TRAY AND 1 BAG

AL50550

- Tubo Inox. Ø 25 mm y 1 mm espesor.
- 1 Bolsa nylon lateral, extraíble color azul.
- Capacidad bolsa 283 L.
- 4 Ruedas giratorias libres Ø 100 mm y 32 mm ancho rodadura goma.
- Ruedas antihilos con núcleo de Polipropileno.
- Totalmente desmontables.
- Freno pedal sobre la rueda.
- Colectividades, Hospitales, Clínicas, Geriátricos, Hoteles, Residencias, etc.
- Stainless Steel tube with Ø 25 mm and 1 mm thick.
- 1 blue nylon removable bag at one side.
- Bag capacity: 283 L.
- 4 free rotating castors with Ø 100 mm and 32 mm wide rubber tread.
- Anti-thread castor with Polypropylene core.
- Entirely detachable.
- Brake pedal at one castor.
- Collectivities, Hospitals, Medical Clinics, Geriatric Hospitals, etc.

Características Técnicas | Technical Characteristics

Características Técnicas Technical Characteristics		AL50550
Material Estructura Structure Material		Inox / Stainless Steel
Acabado Finish		Satinado / Satin
Material Bandejas Trays Material		Polipropileno / Polypropylene
Material Bolsas Bags Material		PVC
Peso Neto/Bruto Net/Gross Weight	(Kg)	10,450 / 11,700

- Hoja instrucciones de montaje y componentes. | Instructions and components (included).
- EMBALAJE: Unitario. | PACKAGING: Single.
- LIMPIEZA: Bayeta húmeda. No usar productos químicos. | CLEANING: Damp cloth. Don't use chemicals.

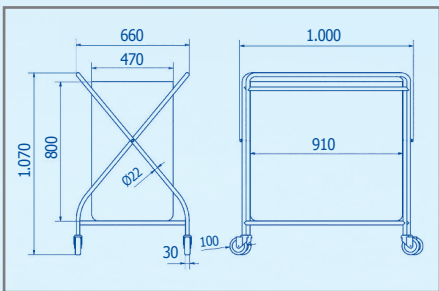

Dimensiones embalaje: (mm) 1.265
Packaging dimensions: 1.010 305

CARRO METÁLICO. 1 MAXI-SACO METAL TROLLEY. 1 MAXI-BAG

AL50600

- Tubo de Inox. Ø 25 mm y 1 mm espesor.
- Parrilla inferior.
- Saco de nylon de 342 L.
- Totalmente plegable.
- 4 Ruedas giratorias libres Ø 100 mm antihilos.
- Saco desmontable y lavable de nylon azul
- Freno pedal sobre la rueda.
- Horeca, Hoteles, Clínicas, Geriátricos, Residencias, Colectividades, Hospitales, etc.
- Stainless Steel tube with Ø 25 mm and 1 mm thick.
- Grill at bottom.
- 1 nylon bag 342 L capacity.
- Entirely foldable.
- 4 free rotating castors with Ø 100 mm an 32 mm wide rubber tread.
- Blue nylon bag, removable and washable
- Brake pedal at one castor.
- Horeca, hotels, medical clinics, hostels, geriatric hospitals, collectivities, hospitals, etc.

Características Técnicas | Technical Characteristics

Características Técnicas Technical Characteristics		AL50600
Material Estructura Structure Material		Inox / Stainless Steel
Acabado Finish		Satinado / Satin
Material Bandejas Trays Material		Polipropileno / Polypropylene
Material Bolsas Bags Material		PVC
Peso Neto/Bruto Net/Gross Weight	(Kg)	11,350 / 13,900

- Hoja instrucciones de montaje y componentes. | Instructions and components (included).
- EMBALAJE: Unitario. | PACKAGING: Single.
- LIMPIEZA: Bayeta húmeda. No usar productos químicos. | CLEANING: Damp cloth. Don't use chemicals.

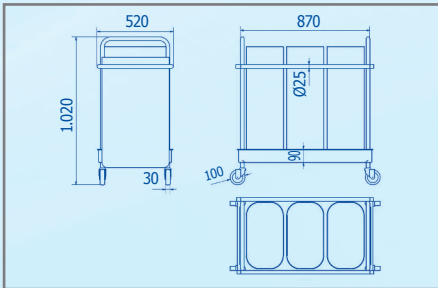

Dimensiones embalaje: (mm) 930
Packaging dimensions: 510 200

CARRO METÁLICO. 1 BANDEJA GRANDE Y 3 o 5 BOLSAS METAL TROLLEY. 1 BIG TRAY, AND 3 or 5 BAGS AL50550C (3 BOLSAS|BAGS) / AL50550CS (5 BOLSAS|BAGS)

- Tubo Inox. Ø 25 mm y 1 mm espesor.
- 1 Bandeja Polipropileno con alzado lateral color gris.
- 3 o 5 Bolsas nylon extraíbles, colores selectivos a elegir.
- Capacidad bolsas 3 x 100 o 5 x 100 L/u.
- 4 Ruedas giratorias libres Ø 100 mm y 32 mm ancho rodadura goma.
- Ruedas antihilo con núcleo de Polipropileno.
- Totalmente desmontable.
- Freno pedal sobre la rueda.
- Colectividades, Hospitales, Clínicas, Geriátricos, Hoteles, Residencias, etc.
- Stainless Steel tube with Ø 25 mm and 1 mm thick.
- 1 grey Polypropylene shelf, with lateral elevation.
- 3 or 5 nylon removable bags, several colours available
- Bags capacity: 3x100 or 5x100 L / each
- 4 free rotating castors with Ø 100 mm 32 mm wide rubber tread.
- Anti-thread castors with Polypropylene core.
- Entirely detachable.
- Brake pedal at one castor.
- Collectivities, hospitals, medical clinics, geriatric hospitals, hotels, hostels, etc.

• **Colores bolsas:**

- Z = Azul
- N = Negro
- R = Rojo
- A = Gris
- B = Blanco

• **Bags colour:**

- Z = Blue
- N = Black
- R = Red
- A = Gray
- B = White



AL50550C

- 3 Bolsas
- 3 Bags



AL50550CS

- 5 Bolsas
- 5 Bags

Características Técnicas Technical Characteristics	AL50550C	AL50550CS
Material Estructura Structure Material	Inox / Stainless Steel	Inox / Stainless Steel
Acabado Finish	Satinado / Satin	Satinado / Satin
Material Bandejas Trays Material	Polipropileno / Polypropylene	Polipropileno / Polypropylene
Material Bolsas Bags Material	PVC	PVC
Peso Neto/Bruto Net/Gross Weight (Kg)	11,110 / 12, 350	11,335 / 12,585
Ø Tubo Ø Tube (mm)	25	25
Espesor Tubo Tube Thickness (mm)	1	1
Nº Ruedas Wheels	4	4
Antihilos Antithread	X	X
Freno Brakes	X	X
Nº Bandejas Trays	1	1
Nº Bolsas Bags	3	5
Capacidad Bolsas Bags Capacity (L)	3 x 100	5 x 100

- Hoja instrucciones de montaje y componentes. Instructions and components (included).
- EMBALAJE: Unitario. | PACKAGING: Single.

- LIMPIEZA: Bayeta húmeda. No usar productos químicos. CLEANING: Damp cloth. Don't use chemicals.

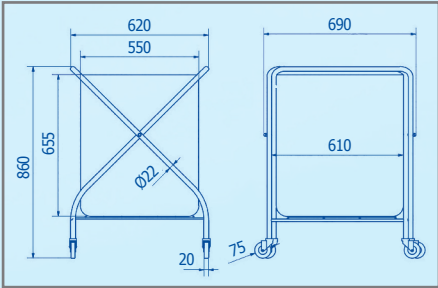

Dimensiones embalaje: (mm) 1.140
Packaging dimensions: 700 270

CARRO METÁLICO. 1 SACO

METAL TROLLEY. 1 BAG

AL99800Z

- Tubo Acero Cromado Ø 25 mm y 1 mm de espesor.
- Parrilla inferior.
- Saco de nylon de 160 L.
- Totalmente plegable.
- 4 Ruedas giratorias libres de Ø 75 mm antihilos.
- Saco desmontable y lavable de nylon azul.
- Freno pedal sobre la rueda.
- Horeca, Hoteles, Clínicas, Hospitales, Geriátricos, Residencias, Colectividades, Hospitales, etc.

- Chromed Steel tube with Ø 25 mm and 1 mm thick.
- Grill bottom.
- 1 nylon bag 160 L capacity.
- Entirely foldable.
- 4 free rotating castors with Ø 100 mm an 32 mm wide rubber tread.
- Blue nylon bag, removable and washable.
- Brake pedal at one castor.
- Horeca, hotels, medical clinics, hostels, geriatric hospitals, collectivities, hospitals, etc.

Características Técnicas | Technical Characteristics

AL99800Z

Material Estructura Structure Material	Acero Cromado / Chromed Steel
Acabado Finish	Brillo / Bright
Material Bandejas Trays Material	Polipropileno / Polypropylene
Material Bolsas Bags Material	PVC
Peso Neto/Bruto Net/Gross Weight (Kg)	6,450 / 8,600

- Hoja instrucciones de montaje y componentes. | Instructions and components (included).
- EMBALAJE: Unitario. | PACKAGING: Single.
- LIMPIEZA: Bayeta húmeda. No usar productos químicos. | CLEANING: Damp cloth. Don't use chemicals.

ACCESORIOS > ACCESSORIES



PROTECTOR CARROS

TROLLEY'S PROTECTOR

RL9010

- Fabricado en ABS.
- Incorpora ruedas de goma encastradas semiocultas.
- Se coloca en los ángulos de los carros.
- Minimiza el impacto.
- Evita deterioro de las paredes.
- Se fija con tornillos a las asas telescópicas.

- Made of ABS plastic
- Includes rubber castors, embedded and half concealed.
- To be placed at trolley's edges.
- Reduces impacts.
- Prevents damages on walls.
- Fixed by means of screws to telescopic handles.



RUEDAS WHEELS

RZ3001 - RZ3002 - RZ3018 - RZ3019 - RZ3021 - RZ3022

- Todos los carros incorporan de serie 3 ruedas sin freno y 1 rueda con freno.
 - Todas con sistema antihilos.
 - Ruedas standard: Plástico con núcleo de Polipropileno Ø 100 mm.
 - 3 RZ3001 Sin freno.
 - 1 RZ3002 Con freno.
 - Van incluidos en el precio del carro.
 - Ruedas especiales: Espuma de alta densidad.
 - Más resistentes.
 - Silenciosas.
 - Semineumática con banda de rodadura de goma.
 - RZ3018 Sin freno Ø 200 mm.
 - RZ3019 Con freno Ø 200 mm.
 - RZ3021 Sin freno Ø 150 mm.
 - RZ3022 Con freno Ø 150 mm.
 - Ruedas libres con giro de 360° y rosca metálica insertado en el tubo de la estructura.
- All the trolleys include 3 castors without brake and one with brake.
 - All have anti-thread system.
 - Standard castors: Plastic with Polypropylene core with Ø 100 mm.
 - 3 RZ3001 Without brake.
 - 1 RZ3002 with brake.
 - Included on the price of the trolley.
 - Special castors: High density foam.
 - More resistant.
 - Quiet.
 - Run-flat castor with rubber tread.
 - RZ3018 without brake, Ø 200 mm.
 - RZ3019 with brake, Ø 200 mm.
 - RZ3021 without brake, Ø 150 mm.
 - RZ3022 with brake, Ø 150 mm.
 - Free rotating castors that turn 360°, metallic thread inserted into the structure tube.



RZ3001



RZ3002



RZ3018



RZ3019



RZ3021



RZ3022

Características Técnicas Technical Characteristics	RZ3001	RZ3002	RZ3018	RZ3019	RZ3021	RZ3022
Material Estructura Structure Material	Plástico / Plastic	Plástico / Plastic	Espuma / Foam	Espuma / Foam	Espuma / Foam	Espuma / Foam
Color Colour	Gris / Grey	Gris / Grey	Gris / Grey	Gris / Grey	Gris / Grey	Gris / Grey
Freno Brakes	—	X	—	X	—	X
Ø Ruedas Ø Wheels (mm)	100	100	200	200	150	150
Antihilos Antithread	X	X	X	X	X	X
Banda Rodadura Goma Rubber Tread	—	—	X	X	X	X

• FIJACIÓN: Rosca metálica insertada en pieza de plástico expansivo, embutida en el tubo de la estructura.
FIXING: Metallic thread inserted into expansive plastic part, placed inside the tube of the structure.

• EMBALAJE: S/Pedido. | PACKAGING: A/Order.
• LIMPIEZA: Bayeta húmeda. No usar productos químicos.
CLEANING: Damp cloth. Don't use chemicals.

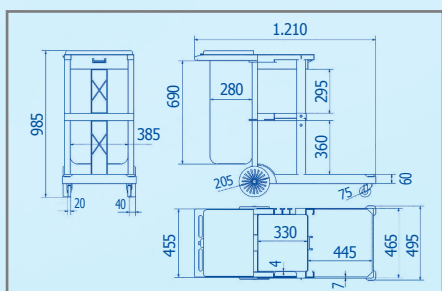

Dimensiones embalaje: (mm) 550
Packaging dimensions: 260 890

CARRO SERVICIO ECO CON BOLSA

SERVICE TROLLEY ECO WITH BAG

AZ16000

- Polipropileno gris claro, desmontable.
- Bandeja grande inferior y 2 superiores pequeñas.
- 2 Ruedas grandes traseras fijas y 2 delanteras pequeñas libres.
- Tapa abatible y bolsa grande desmontable y extraíble de 82 L.
- Preparado para transportar Carro Monoseno JOFEL refs.: AZ20700/20700C.
- Universal, económico y de grandes prestaciones.
- Light grey Polypropylene, detachable.
- 1 large shelf at the bottom and two smaller at the top.
- 2 large fixed wheels at the back and 2 free rotating castors at the front.
- Reclining lid, large removable bag, 82 L capacity.
- Conceived to carry single bucket JOFEL refs.: AZ20700/20700C.
- Universal, low cost and high performance.

Características Técnicas | Technical Characteristics

		AZ16000
Material Material		Polipropileno / Polypropylene
Acabado Finish		Gris / Grey
Peso Neto/Bruto Net/Gross Weight	(Kg)	12,600 / 13,640
Bandeja Grande Large Tray		1
Nº Bandejas Pequeñas Small Trays		2
Nº Ruedas Wheels		2 + 2
Bolsa Bag	(L)	82

- EMBALAJE: Unitario. | PACKAGING: Single.
- LIMPIEZA: Bayeta húmeda. No usar productos químicos. | CLEANING: Damp cloth. Don't use chemicals.

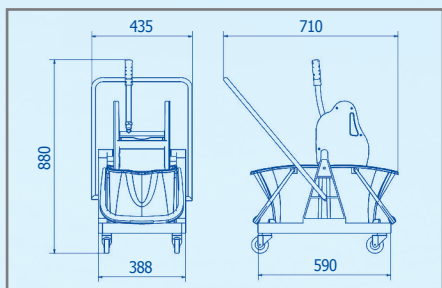

Dimensiones embalaje: (mm) 415
Packaging dimensions: 630 430

CARRO AUTOPORTANTE ECO

FULL SELF CARRYING ECO

AZ21600

- Polipropileno gris claro con brazo metálico móvil.
- Prensa/escurreidor extraíble con palanca metálica (incluida).
- 2 Cubos (azul/rojo) de 15 L con canalización.
- 4 Ruedas pequeñas giratorias libres Ø 80 mm.
- Ruedas de nylon soportando hasta 50 Kg/u desmontables.
- Uso Universal, especialmente para Horeca y Hospitales.
- Light grey Polypropylene, movable metallic handle
- Removable wringer with metallic handle (included).
- 2 buckets (blue/red) 15 L capacity each, with lip for pouring.
- 4 small free rotating castors, Ø 80 mm.
- Nylon castors that can bear up to 50 Kg/u, removable
- Widespread use, especially for Horeca and Hospitals.

Características Técnicas | Technical Characteristics

		AZ21600
Material Material		Polipropileno / Polypropylene
Color Colour		Azul / Blue
Nº Cubos Buckets		2
Peso Neto/Bruto Net/Gross Weight	(Kg)	8,140 / 9,425
Capacidad Volume	(L)	2 x 15
Ø Ruedas Ø Wheels	(mm)	80
Nº de Ruedas Libres Free Wheels		4

- EMBALAJE: Unitario. | PACKAGING: Single.
- LIMPIEZA: Bayeta húmeda. No usar productos químicos. | CLEANING: Damp cloth. Don't use chemicals.

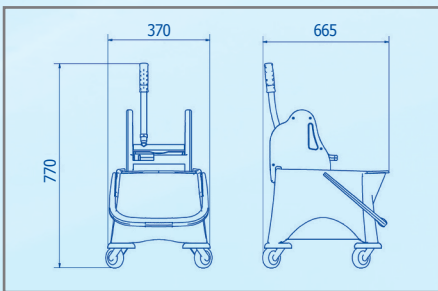

Dimensiones embalaje: (mm) 495
Packaging dimensions: 375 320

CUBO MONOSENSO ECO (32 L) CON PRENSA BUCKET SINGLE ECO (32 L) WITH MOP WRINGER AZ20700C

- Polipropileno color azul con prensa extraíble y 32 L.
- 4 ruedas libres con protección anti-impactos y cambiables.
- Prensa con palanca metálica, resistente, uso Universal (incluida).
- Cubo con canalización para vertido fácil.
- Asa metálica.
- Se acopla al Carro Servicio JOFEL refs.: AZ16000/AL50250.
- Blue Polypropylene, removable wringer, 32 L.
- 4 free rotating castors, protected from impacts and changeable.
- Wringer with resistant metallic handle, universal use (included).
- Bucket has lip for easy pouring.
- Metallic handle.
- Suitable for service trolley JOFEL refs.: AZ16000/AL50250.

Características Técnicas Technical Characteristics	AZ20700C
Material Material	Polipropileno / Polypropylene
Color Colour	Azul / Blue
Peso Neto/Bruto Net/Gross Weight (Kg)	5,350 / 5,845
Capacidad Volume (L)	32
Ø Ruedas Ø Wheels (mm)	50
Nº de Ruedas Libres Free Wheels	4

- EMBALAJE: Unitario. | PACKAGING: Single.
- LIMPIEZA: Bayeta húmeda. No usar productos químicos. | CLEANING: Damp cloth. Don't use chemicals.

ACCESORIOS > ACCESSORIES

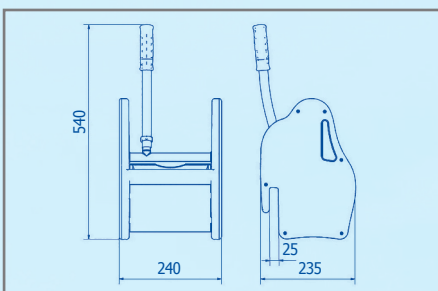

Dimensiones embalaje: (mm) 370
Packaging dimensions: 270 490

PRENSA EUROPEA EUROPEAN MOP WRINGER AZ25500G

- Polipropileno gris claro y Poliamidas.
- Extraíble y encajable fácilmente en cubo.
- Mango metálico resistente Inox.
- Prensa adaptada a fregona europea.
- Prensa incorporable a cualquier carro/cubo limpieza.
- Empuñadura ergonómica de plástico superpuesto.
- Colectividades, Horeca.
- Light grey Polypropylene and Polyamides.
- Removable, fits bucket easily.
- Resistant metallic handle of Stainless Steel.
- Wringer adapted to european mops.
- Suitable for any cleaning trolley/bucket.
- Ergonomic plastic grip superposed.
- Collectivities, Horeca.

Características Técnicas Technical Characteristics	AZ25500G
Material Material	Polip-Poliam / Polyp-Polyam
Color Colour	Gris / Grey
Peso Neto/Bruto Net/Gross Weight (Kg)	2,480 / 5,610 (2 u.)
Palanca Lever	Aluminio / Aluminium
Empuñadura Handle	Plástico / Plastic
Lamas Presión Pressure Sheets	2

- UTILIZACIÓN: Fregonas europeas. | USE: European mops.
- USO: Colectividades, Horeca. | USE: Collectivities, Horeca.
- LIMPIEZA: Bayeta húmeda. No usar productos químicos. | CLEANING: Damp cloth. Don't use chemicals.

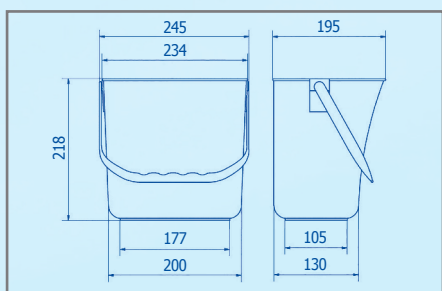

Dimensiones embalaje: (mm) 375
Packaging dimensions: 265

CUBETA 6 L PLASTIC BUCKET 6 L AZ29000R - AZ29000Z

- Polipropileno color rojo (R) o azul (Z).
- Asa plástico movable y ergonómica, gris.
- Geometría troncopiramidal.
- Apilables y de 6 L de capacidad.
- Ligera, resistente y de larga duración.
- Cajas de 4 unidades.
- Uso Universal.

- Red (R) or blue (Z) Polypropylene.
- Ergonomic and movable plastic handle, grey.
- Tapered shape.
- Stackable, 6 L capacity.
- Light, resistant, long lasting life.
- 4 units packaging.
- Widespread use.



AZ29000R

- Polipropileno Rojo
- Polypropylene Red

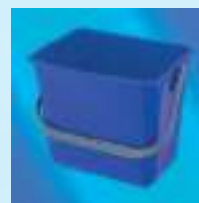

AZ29000Z

- Polipropileno Azul
- Polypropylene Blue

Características Técnicas Technical Characteristics	AZ29000R	AZ29000Z
Peso Neto/Bruto Net/Gross Weight (Kg)	0,370 / 1,640 (4 u.)	0,370 / 1,640 (4 u.)

- USO: Universal. | USE: Universal.
- EMBALAJE: 4 u. | PACKAGING: 4 u.
- LIMPIEZA: Bayeta húmeda. No usar productos químicos. | CLEANING: Damp cloth. Don't use chemicals.

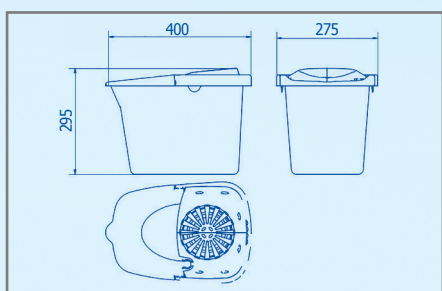

Dimensiones embalaje: (mm) 840
Packaging dimensions: 410

CUBO CON ESCURRIDOR BUCKET WITH WRINGER TICC150TJR - TICC150TJZ

- Polipropileno color rojo (R) o azul (Z).
- Asa plástica, ergonómica, resistente y movable.
- Geometría troncopiramidal.
- Apilables y de 15 L de capacidad.
- Escurridor plástico extraíble, fijado a presión.
- Escurridor con asidero antiderrame de agua.
- Canalización para facilitar desagüe.
- Uso Universal.

- Red (R) or blue (Z) Polypropylene.
- Resistant plastic handle, ergonomic and movable.
- Tapered shape.
- Stackable, 15 L capacity.
- Removable plastic wringer, fixed by pressure.
- Wringer with handhold, anti-spill of water.
- Frontal lip for easy emptying.
- Widespread use.



TICC150TJR

- Polipropileno Rojo
- Polypropylene Red



TICC150TJZ

- Polipropileno Azul
- Polypropylene Blue

Características Técnicas Technical Characteristics	TICC150TJR	TICC150TJZ
Peso Neto/Bruto Net/Gross Weight (Kg)	0,775 / 9,350 (12 u.)	0,775 / 9,350 (12 u.)
Asa Gris Grey Handle	Plástico / Plastic	Plástico / Plastic

- EMBALAJE: 12 u. | PACKAGING: 12 u.
- LIMPIEZA: Bayeta húmeda. No usar productos químicos. | CLEANING: Damp cloth. Don't use chemicals.



MANGO DE ALUMINIO ANODIZADO ANODISED ALUMINIUM STICK

TICM14AA40

- Aluminio anodizado.
- Color plata.
- Doble rosca para sujeción y diferentes diámetros.
- Longitud 155 cm.
- Empuñadura ergonómica plástica negra.
- Cavidad en el extremo para colgar.
- Anodised aluminium.
- Silver colour.
- Double thread for fixing, several diametres available.
- Length: 155 cm.
- Black plastic grip, ergonomic.
- Hole at the end of grip to hang it up.

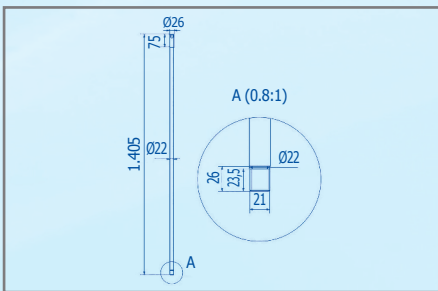

Dimensiones embalaje: (mm) 1.570
Packaging dimensions: 105 105

Características Técnicas Technical Characteristics	TICM14AA40
Material Material	Aluminio / Aluminium
Acabado Finish	Anodizado / Anodised
Color Colour	Plata / Silver
Peso Neto/Bruto Net/Gross Weight (Kg)	0,280 / 3,300 (12 u.)
Longitud Length (cm)	155
Empuñadura/Color Color Handle	Plástico Negro / Black Plastic

- EMBALAJE: 12 u. | PACKAGING: 12 u.
- LIMPIEZ: Bayeta húmeda. No usar productos químicos. | CLEANING: Damp cloth. Don't use chemicals.



MANGO DE ALUMINIO PLASTIFICADO LAMINATED ALUMINIUM STICK

TICM14AF23Z

- Aluminio de alta calidad.
- Parcialmente plastificado.
- Doble rosca para sujeción y diferentes diámetros.
- Longitud 140 cm.
- Empuñadura ergonómica plástica azul.
- Cavidad en el extremo para colgar.
- High quality aluminium.
- Partially laminated.
- Double thread for fixing, several diametres available.
- Length: 140 cm.
- Blue plastic grip, ergonomic
- Hole at the end of grip to hang it up.

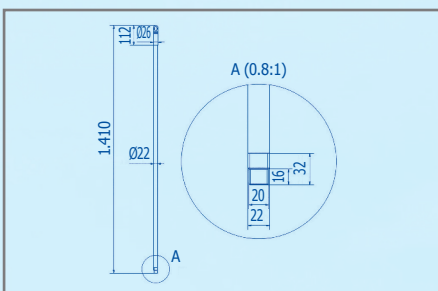

Dimensiones embalaje: (mm) 1.420
Packaging dimensions: 105 105

Características Técnicas Technical Characteristics	TICM14AF23Z
Material Material	Aluminio / Aluminium
Acabado Finish	Plástico / Plastic
Color Colour	Azul / Blue
Peso Neto/Bruto Net/Gross Weight (Kg)	0,130 / 2,095 (12 u.)
Longitud Length (cm)	140
Empuñadura/Color Color Handle	Plástico Azul / Blue Plastic

- EMBALAJE: 12 u. | PACKAGING: 12 u.
- LIMPIEZ: Bayeta húmeda. No usar productos químicos. | CLEANING: Damp cloth. Don't use chemicals.



SEÑAL PELIGRO PLASTIC WARNING SIGN AZ60001

- Polipropileno color amarillo.
- Triangular, plegable y desmontable.
- Asa integrada en parte superior.
- Pictogramas en ambas caras.
- Texto en: Español, Francés, Inglés, y Alemán.
- Uso Universal.
- Yellow Polypropylene.
- "A" frame, foldable and detachable.
- Integrated handle at top.
- Pictograms on both sides.
- Text in: Spanish, French, English and German.
- Widespread use.

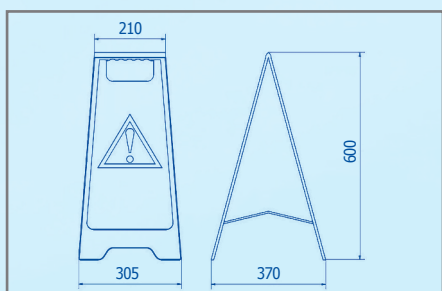

Dimensiones embalaje: (mm) 655
Packaging dimensions: 320 320

Características Técnicas | Technical Characteristics

		AZ60001
Material Material		Polipropileno / Polypropylene
Color Colour		Amarillo / Yellow
Peso Neto/Bruto Net/Gross Weight	(Kg)	0,866 / 9,430 (10 u.)

- EMBALAJE: 10 u. | PACKAGING: 10 u.
- LIMPIEZA: Bayeta húmeda. No usar productos químicos. | CLEANING: Damp cloth. Don't use chemicals.

CENICERO > ASHTRAY

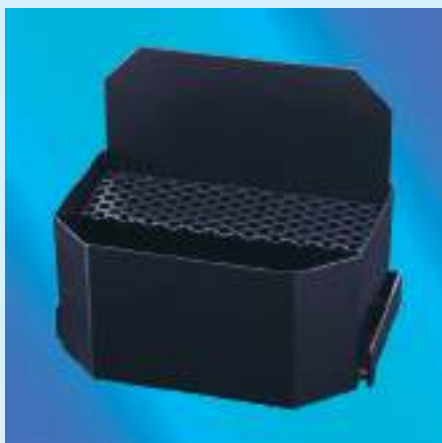

CENICERO EXTERIOR PARED ABATIBLE WALL MOUNTED RECLINING ASHTRAY AL93100

- Chapa electrocincada.
- Pintado en Poliéster.
- Colores a elegir.
- Antivandálico.
- Atornillado a pared el soporte.
- Capacidad 0,8 L
- Espesor 1 mm.
- Abatible.
- Parte trasera más alta para proteger pared.
- Encimera perforada.
- Cerradura de fijación con llave.
- Electro zinc coated Steel Sheet.
- Polyester paint.
- Several colours to choose.
- Antivandalism.
- Support fixed to wall by screws.
- 0,8 L capacity.
- 1 mm thick.
- Reclining.
- Rear part higher to protect wall.
- Perforated extinguishing screen.
- Fixing lock with key.

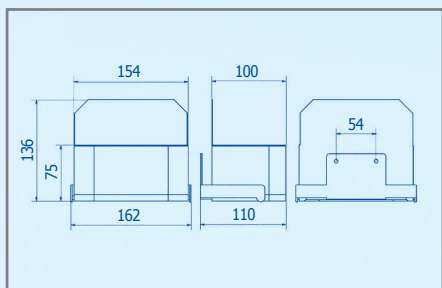

Dimensiones embalaje: (mm) 530
Packaging dimensions: 230 225

Características Técnicas | Technical Characteristics

		AL93100
Material Material		Chapa / Steel Sheet
Acabado Finish		Poliéster / Polyester
Color Colour		A elegir / Choose
Peso Neto/Bruto Net/Gross Weight	(Kg)	0,660 / 0,6925

- FIJACIÓN: A pared mediante 2 tornillos + 2 tacos (incluidos). | FIXING: To wall with 2 screws + 2 wall plugs (included).
- EMBALAJE: Unitario. | PACKAGING: Single.
- LIMPIEZA: Bayeta húmeda. No usar productos químicos. | CLEANING: Damp cloth. Don't use chemicals.

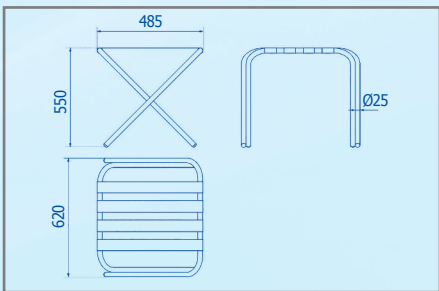

Dimensiones embalaje: (mm) 720
Packaging dimensions: 630 65

REPOSAMALETAS METÁLICO METAL LUGGAGE RACK

AL40000

- Tubo Acero pintado Poliéster cromo.
- Doble tratamiento.
- Pintura anticorrosiva.
- Pintura y barniz Poliéster.
- Plegable, reducido espacio.
- Soporte de fibras de nylon negras.
- Tacos de nylon antideslizantes.
- Fácil limpieza y mantenimiento.
- Steel tube, Polyester painted chrome.
- Double treatment.
- Rust resistant paint.
- Paint and varnish of Polyester.
- Foldable, takes little space.
- Straps made of black nylon fibres.
- Non-slip nylon pads.
- Easy to clean and maintain.

Características Técnicas | Technical Characteristics

		AL40000
Material Material		Acero / Steel
Acabado Finish		Cromado / Chromed
Peso Neto/Bruto Net/Gross Weight	(Kg)	2,450 / 2,800
Ø Tubo Ø Tube	(mm)	25
Nº Soportes Supports		4

- EMBALAJE: Unitario. | PACKAGING: Single.
- LIMPIEZA: Bayeta húmeda. No usar productos químicos. | CLEANING: Damp cloth. Don't use chemicals.

PARAGÜEROS > UMBRELLA HOLDERS

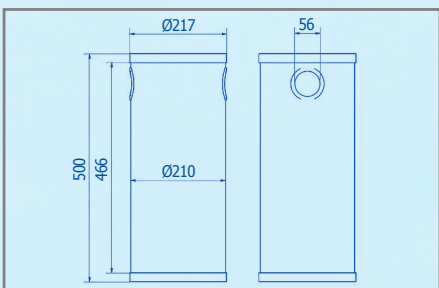

Dimensiones embalaje: (mm) 525
Packaging dimensions: 230 230

PARAGÜERO CILÍNDRICO CYLINDRICAL UMBRELLA STAND

AL95000 - AL95002 - AL95101 - AL95301

- Capacidad 20 L.
- Aros protección/decorativos en boca.
- Aislamiento de ABS en la base.
- Geometría cilíndrica (Ref 95301 con asas).
- Con plato recoge-aguas.
- 20 L capacity.
- Protection and ornamental bands at top.
- Insulation ABS at the bottom.
- Cylindrical shape (Ref 95301 with handles).
- Tray for water at bottom.



AL95000

- Chapa
- Steel Sheet



AL95002

- Chapa
- Steel Sheet



AL95101

- Inox
- Stainless Steel



AL95301

- Inox
- Stainless Steel

Características Técnicas | Technical Characteristics

	AL95000	AL95002	AL95101	AL95301
Material Material	Chapa / S.Sheet	Chapa / S.Sheet	Inox / S.Steel	Inox / S.Steel
Acabado Finish	Poliéster / Polyester	Poliéster / Polyester	Satinado / Satin	Satinado / Satin
Color Colour	A elegir / Choose	A elegir / Choose	—	—
Asas Handles	—	—	—	X
Aros Rings	ABS	ABS	ABS	ABS
Color Colour	Negro / Black	Cromado / Chromed	Cromado / Chromed	Cromado / Chromed
Peso Neto/Bruto Net/Gross Weight	(Kg) 2,310 / 2,605	2,310 / 2,605	2,195 / 2,505	2,410 / 2,800
Espesor Thickness	(mm) 1	1	0,8	0,8

- EMBALAJE: Unitario. | PACKAGING: Single.
- LIMPIEZA: Bayeta húmeda. No usar productos químicos. | CLEANING: Damp cloth. Don't use chemicals.

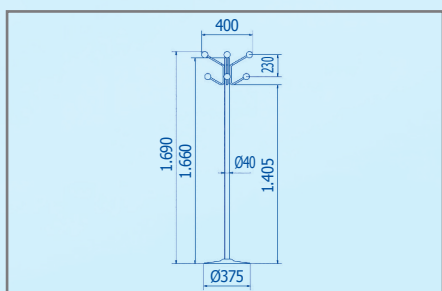

Dimensiones embalaje: (mm) 870
Packaging dimensions: 395 410

- EMBALAJE: Unitario. | PACKAGING: Single.
- LIMPIEZA: Bayeta húmeda. No usar productos químicos. | CLEANING: Damp cloth. Don't use chemicals.

PERCHERO METÁLICO PIE METALLIC COAT STAND

AL90100

- Tubo de acero Ø 40 mm cromado.
- Pintado en Poliéster.
- Color a elegir.
- Desmontable con dos niveles de colgadores en círculo.
- Espesor tubo 1,5 mm.
- Colgadores de 8 bolas de ABS cromado.
- Máxima capacidad y mínimo espacio.
- Movable.
- Establecimientos públicos y privados.
- Steel tube with Ø 40 mm, chrome coated.
- Polyester painted.
- Several colours to choose.
- Detachable, two hook levels.
- Tube thickness: 1,5 mm.
- 8 hooks, ball shaped, of chrome ABS.
- Maximum capacity with reduced dimensions.
- Movable.
- For private and public environments.

Características Técnicas | Technical Characteristics

Características Técnicas Technical Characteristics		AL90100
Material Material		Chapa / Steel Sheet
Acabado Finish		Poliéster / Polyester
Color Colour		A elegir / Choose
Peso Neto/Bruto Net/Gross Weight	(Kg)	6,990 / 7,650
Ø Tubo Ø Tube	(mm)	40
Espesor Tubo Tube Thickness	(mm)	1,5
Ø Base Ø Base	(mm)	375
Nº Bolas Balls		8
Desmontable Detachable		X

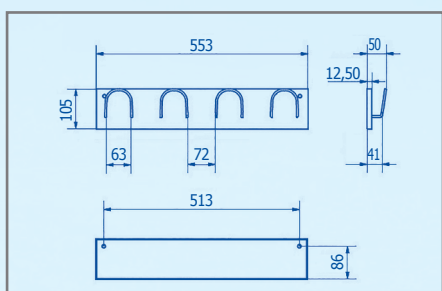

Dimensiones embalaje: (mm) 370
Packaging dimensions: 560 265

PERCHERO PARED WALL HANGER

AL91000

- Chapa electrocincada.
- Pintada en Poliéster.
- Colores a elegir.
- Espesor 1 mm.
- Base placa metálica.
- Fijada a pared por tornillos y tacos.
- Cuatro colgadores en forma de arco semicírculo de varilla.
- Resistente a la oxidación.
- Larga duración.
- Establecimientos públicos y privados.
- Electro zinc coated Steel Sheet.
- Polyester painted.
- Several colours to choose.
- 1 mm thick.
- Base metallic plate.
- 4 wall by means of screws and wall plugs.
- Four hooks with half circle shape.
- Rust resistant.
- Long lasting life.
- Public and private facilities.

Características Técnicas | Technical Characteristics

Características Técnicas Technical Characteristics		AL91000
Material Material		Chapa / Steel Sheet
Acabado Finish		Poliéster / Polyester
Color Colour		A elegir / Choose
Peso Neto/Bruto Net/Gross Weight	(Kg)	0,610 / 0,628
Nº Aros Rings		4

- FIJACIÓN: A pared mediante 2 tornillos + 2 tacos (incluidos). | FIXING: To wall with 2 screws + 2 wall plugs (included).
- EMBALAJE: Unitario. | PACKAGING: Single.
- LIMPIEZA: Bayeta húmeda. No usar productos químicos. | CLEANING: Damp cloth. Don't use chemicals.

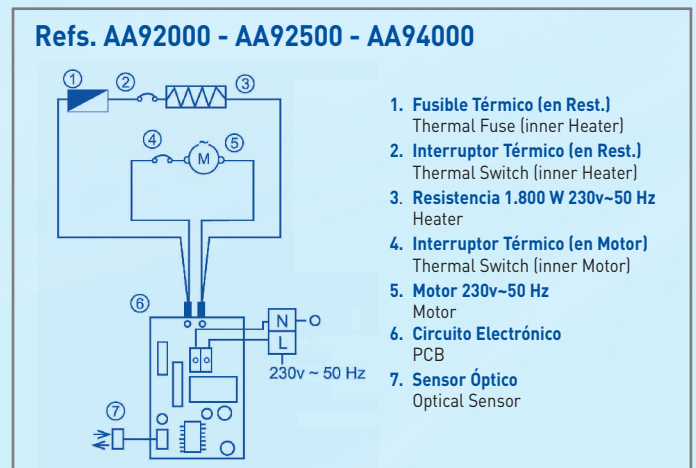
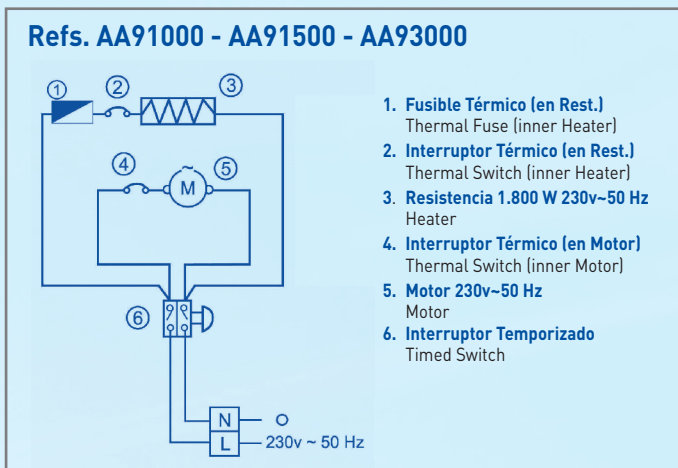
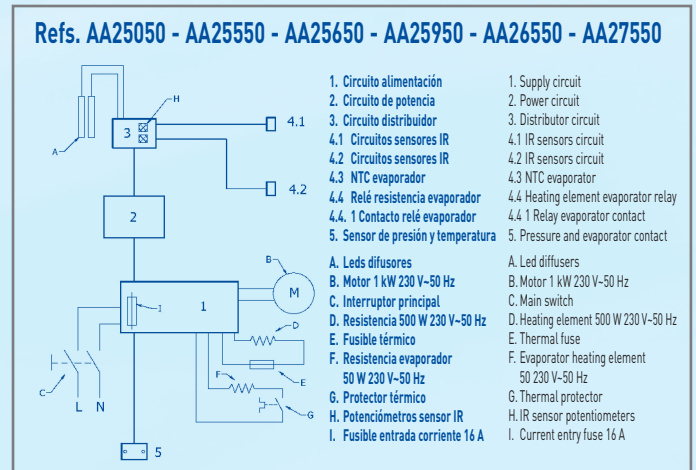
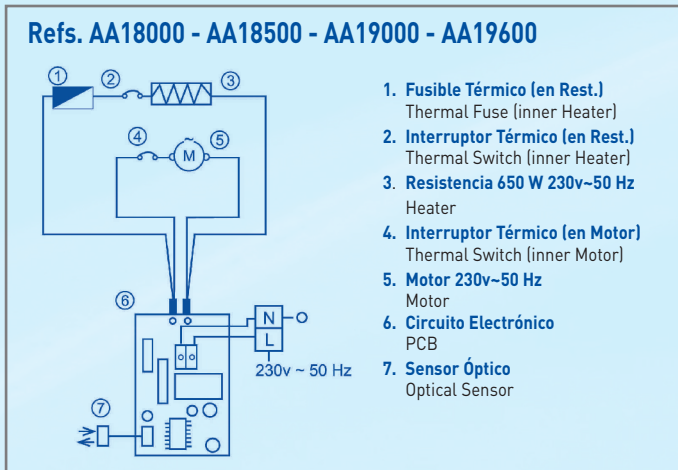
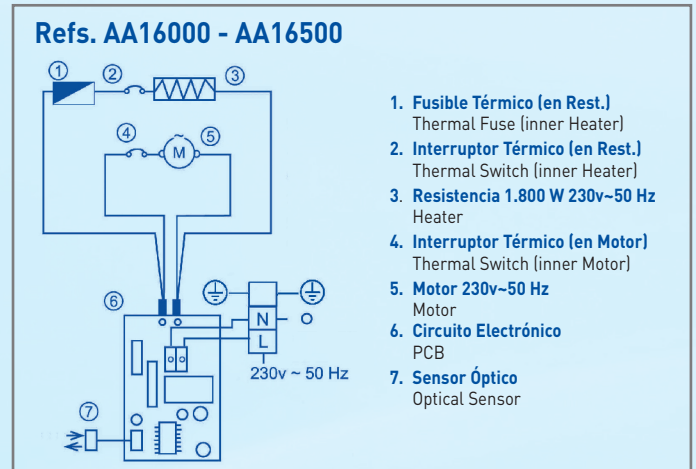
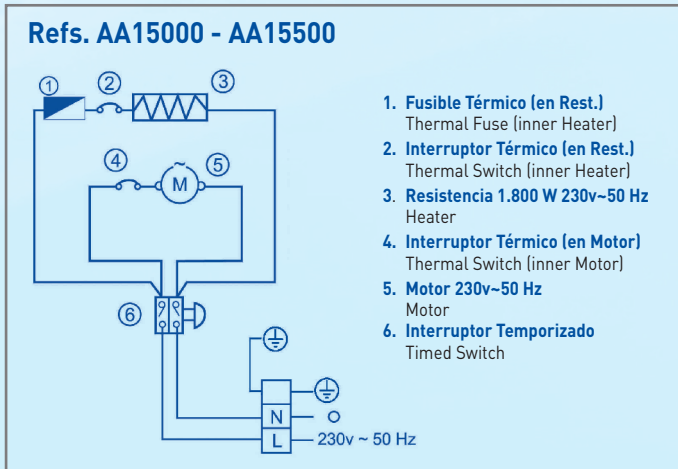
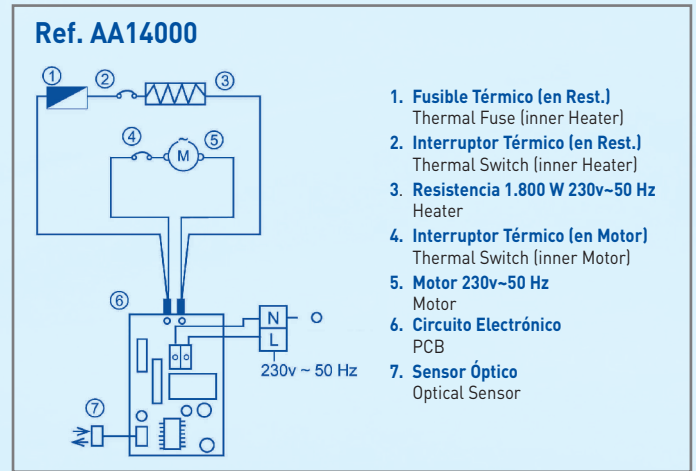
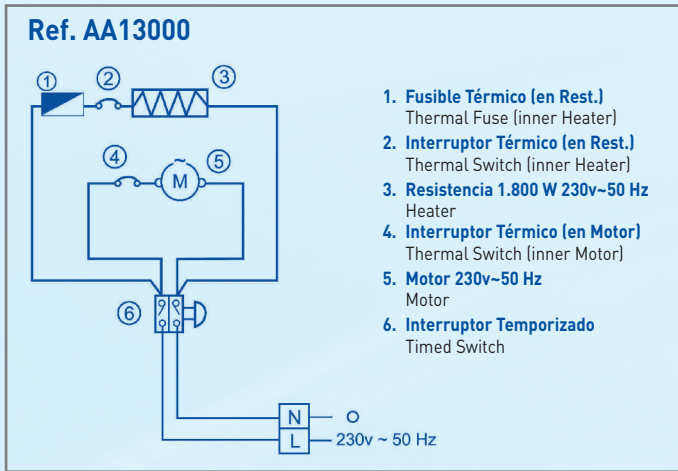

Ref.	Pág. Pág.	Ref.	Pág. Pág.	Ref.	Pág. Pág.	Ref.	Pág. Pág.	Ref.	Pág. Pág.	Ref.	Pág. Pág.
AA13000 21	AC27050 27	AC91000 36	AE67400 44	AG47000 52	AH66500 59
AA14000 21	AC27600 34	AC91050 30	AE67600 44	AG47600 52	AH70000 56
AA15000 21	AC27650 27	AC91070 30	AE77000 44	AG56000 53	AH71200 56
AA15500 21	AC41000 35	AC96000 30	AF11000 46	AG56600 53	AH71400 56
AA16000 21	AC46000 35	AC96500 34	AF12000 46	AG57000 53	AH75000 56
AA16500 21	AC46500 35	AD10000 41	AF21000 46	AG58000 53	AH75500 56
AA18000 22	AC53000 35	AD30000 41	AF22000 46	AG59000 53	AI90000 60
AA18500 22	AC53050 31	AE12100 42	AF50000 46	AG59500 53	AJ12000 61
AA19000 22	AC53500 35	AE12150 42	AF51200 46	AH12000 54	AJ21500C 61
AA19600 22	AC53550 31	AE12400 42	AF51400 46	AH14000 54	AJ21510 62
AA25050 20	AC54000 31	AE13300 42	AF55000 47	AH20000 54	AJ22010 62
AA25550 20	AC54500 31	AE21000 42	AF55500 47	AH25000 54	AJ22510 62
AA25650 20	AC62000 33	AE23000 42	AG14800 48	AH25500 54	AJ23510 62
AA25950 20	AC63000 33	AE24300 42	AG15500 48	AH33000 55	AJ36000 63
AA26550 20	AC70000 28	AE25000 45	AG16500 48	AH33700 55	AJ54000C 61
AA27550 20	AC70600 28	AE25500 45	AG17550 48	AH34200 55	AJ54010 62
AA91000 23	AC70700 28	AE26000 45	AG18550 48	AH34400 55	AJ55010 62
AA91500 23	AC70800 28	AE26500 45	AG19800 48	AH37000 55	AJ56010 62
AA92000 23	AC71000 26	AE51000 43	AG20020 49	AH37600 55	AJ57010 62
AA92500 23	AC72000 28	AE51050 43	AG21050 49	AH38000 55	AJ60000 63
AA93000 23	AC75000 29	AE51700 43	AG32000 49	AH45000 47	AJ80000 64
AA94000 23	AC79000 28	AE52200 43	AG33200 49	AH46000 47	AKA2001 60
AB64180NC 24	AC79500 28	AE52400 43	AG33400 49	AH50000 57	AKA2002 60
AB65000 25	AC80000 35	AE53060 43	AG35000 50	AH52000 57	AKA2003 60
AB65000GC 25	AC80050 31	AE55000 43	AG35500 50	AH52600 57	AKA2004 60
AB65000NC 25	AC81200 35	AE55300 43	AG40000 51	AH52800 57	AKA2015 60
AB65180NC 25	AC81250 31	AE56000 43	AG40700 51	AH53000Z 58	AKA2016 60
AB68500 25	AC81400 35	AE56300 43	AG41200 51	AH54000Z 58	AKA2020 60
AB80000 24	AC81450 31	AE57000 44	AG41400 51	AH60000 59	AKA2021 60
AC14000 29	AC82000 27	AE57600 44	AG42000 51	AH61200 59	AKB4001 69
AC21150 26	AC82020 27	AE58300 43	AG43000 51	AH61400 59	AKB5001 69
AC22000 26	AC84000 27	AE58500 43	AG45000 50	AH65000 59	AKI2002 64
AC27000 34	AC84020 27	AE67000 44	AG45500 50	AH66000 59	AKJ2000 64

Ref.	Pág. Pág.	Ref.	Pág. Pág.	Ref.	Pág. Pág.	Ref.	Pág. Pág.	Ref.	Pág. Pág.		
AKM1001 69	AL70760 104	AL73111 91	ALL1006B 32	AV10840 71	AW61300 80
AL36000 82	AL709100 100	AL74025SV 99	AM20040 65	AV14700 71	AW62000 74
AL36050 82	AL709101 100	AL74040SV 99	AM21000 65	AV14830 71	AW71300 80
AL40000 117	AL709200 100	AL75500 98	AM21500 65	AV14840 71	AW72300 81
AL50050 106	AL709201 100	AL81200 92	AM30225 66	AV40320 72	AW81300 81
AL50150 106	AL709300 100	AL81200ES 92	AM32000 66	AV40400 72	AY10000 52
AL50250 107	AL709301 100	AL81340 98	AM32800 66	AV40500 72	AY11000 52
AL50350 107	AL71200 86	AL81400 93	AM40000 67	AV40600 72	AZ16000 112
AL50550 108	AL71200ES 86	AL81400ES 93	AM41000 67	AV40800 72	AZ20700C 113
AL50550C 109	AL71300 86	AL82200 94	AM50000 68	AV44320 72	AZ21600 112
AL50550CS 109	AL71300ES 86	AL82201 94	AN10000 68	AV44400 72	AZ25500G 113
AL50600 108	AL71400 105	AL82211 94	AN20000 68	AV44500 72	AZ29000R 114
AL60000 82	AL71412 105	AL83801 95	AT10000 33	AV44600 72	AZ29000Z 114
AL60001 82	AL71600 87	AL83811 95	AT14000 37	AV44800 72	AZ60001 116
AL60002 82	AL71601 87	AL88200 95	AT14500 37	AV60600 73	RE2001 45
AL60010E 83	AL71621 87	AL88201 95	AT14700 37	AV70400 73	RE2002 45
AL60010N 83	AL716251 87	AL88210 95	AT16000 37	AV84400 73	RE2003 45
AL61008 83	AL71700 85	AL88211 95	AT16500 37	AW10330 75	RE2004 45
AL61015 83	AL71900 88	AL89001 96	AT16700 38	AW10340 75	RE2005 45
AL70200 84	AL71910 89	AL89101 96	AT51280 38	AW10360 75	RL9010 110
AL70201 84	AL72003C 87	AL90100 118	AT51380 38	AW11300 76	RM1004 103
AL70300 84	AL72005C 87	AL91000 118	AT51580 38	AW21000 74	RM1006 103
AL70301 84	AL72012C 87	AL93100 116	AT52280 39	AW21300 74	RZ3001 111
AL70500 85	AL72020C 87	AL95000 117	AT52380 39	AW22000 75	RZ3002 111
AL70501 85	AL72025SV 99	AL95002 117	AT52580 39	AW22300 75	RZ3018 111
AL70700BG 97	AL72035SV 99	AL95101 117	AT53280 39	AW23300 76	RZ3019 111
AL707050 101	AL72050SV 99	AL95301 117	AT53380 40	AW31300 77	RZ3021 111
AL707051 101	AL72200 90	AL96000 97	AT53580 40	AW34300 77	RZ3022 111
AL707100 105	AL72201 90	AL96001 97	AT95000 40	AW41300 78	TICC150TJR	... 114
AL707120 105	AL72500 90	AL99800Z 110	AT96000 40	AW42300 78	TICC150TJZ	... 114
AL70750BG 97	AL72700 88	ALL1003 32	AV10600 71	AW43300 79	TICM14AA40	.. 115
AL707550 102	AL72710 89	ALL1003B 32	AV10700 71	AW51300 79	TICM14AF23Z	115
AL707551 102	AL73101 91	ALL1006 32	AV10830 71	AW61000 74		



ESPAÑA / SPAIN

**CENTRAL Y FÁBRICA
H.OFFICE AND FACTORY**

Ctra. Madrid, Km 4
C/ La Rioja, n.º 3
03006 ALICANTE
Tel.: +(34) 965 10 45 33
Fax: +(34) 965 10 95 04
+(34) 965 10 45 88 (Export)
Email: pedidos@jofel.com
acliente@jofel.com
jofel@jofel.com (Export)
www.jofel.com

PORTUGAL

Tel.: +(34) 965 10 85 42
+(35) 19 65 45 33 92
Email: jlopes@jofel.com
pedidos@jofel.com
acliente@jofel.com
www.jofel.com

FRANCIA / FRANCE

19, Avenue de la Sablière
Zone d'activité de la Sablière
94370 SUCY en BRIE (Paris)
Tél.: +(33) 01 56 74 11 62
Fax: +(33) 01 49 82 72 58
Email: jofel@jofel.fr
www.jofel.com

ATENCION AL CLIENTE

TEL. +(34) 902 40 50 85
FAX. +(34) 902 40 50 86

MEXICO

**CENTRAL Y FÁBRICA
H. OFFICE AND FACTORY**
Calzada Colorines, n.º 9
Colonia Emiliano Zapata
C.P. 72870 San Andrés de Cholula
PUEBLA
Tel.: +(52) 22 22 84 02 03
Email: atn.puebla@jofel.com.mx

USA

4101 McEwen Rd.
DALLAS, TEXAS Suite# 605 - 75244-5112
Phone: +1 (972) 770-0093
Fax: +1 (972) 770-0097
Cell: +1 (972) 754-9404
Email: customerservice@jofelusa.com
www.jofelusa.com

OFICINA COMERCIAL COMMERCIAL OFFICE

Dtor. Enrique González Martínez, n.º 224
Colonia Santa María de la Ribera
C.P. 06400 CIUDAD DE MEXICO
Tel.: +(52) 55 56 74 80 23
Email: atn.mexico@jofel.com.mx
atn.latinamerica@jofel.com.mx
www.jofel.com.mx

